

Multipole connectors - **T-TYPE** enclosures Standard & **Hygienic** Series

ENGLISH

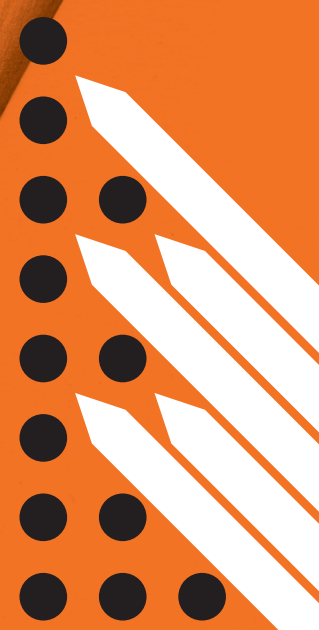

The company and the product

I.L.M.E. SpA - **INDUSTRIA LOMBARDA MATERIALE ELETTRICO** - has been operating in **Milan since 1938**, in particular in the electrotechnical sector for the manufacture of equipment for industrial installations.

ILME reflects the traditional **entrepreneurial spirit of Lombardy**, and has enjoyed continuous expansion for over half a century. The company has carved an important role for itself in the principal world markets, also operating directly in the countries that have assumed world leadership in the field of automation, including Germany and Japan.

In the **electrical connection** sector with applications in industrial automation, characterised by **top performance** and utmost **reliability** needs, ILME is today the acknowledged partner of many leading companies worldwide.



The company's fundamental values are: **Product innovation**, original solutions, excellent **price-quality ratio**, a customer-oriented **service**, ethical behaviour and respect for the environment.

To promote the continuing improvement of its qualitative **results**, ILME has always encouraged its collaborators to work with maximum **responsibility and participation**.

The company focuses on a series of benefits to the user, including research into the most suitable materials, high quality and safe cabling, a rapid turnaround and readily available services.

CE marking

As from 1 January 1997, in order to launch electrical products on the European market the manufacturer must ensure these bear the relevant CE mark, in line with the Low Voltage Directive 73/23/EEC* (implemented in Italy as L. D. 18-10-1977 no. 791) and its modification 93/68/EEC* (implemented in Italy as L. D. 25-11-1996 no. 626/96, published in the supplement to the Gazzetta Ufficiale of 14-12-1996).

The mark must be visible on the product or, if this is not possible, on the packaging, the instructions for use or on the warranty certificate. It acts as a declaration by the manufacturer that the product complies with all relevant EU directives regarding its field of application.

ILME products bear the CE mark on the actual product or its packaging.

Almost all ILME products fall within the field of application of the Low Voltage Directive. A declaration of conformity is required in order to be able to apply the CE mark. This declaration, to which the market is not directly entitled, must be made available to the controlling authorities (in Italy, the Ministry for Industry, Commerce and Handicraft) at all times. In it, the manufacturer declares the technical safety standard(s) followed in the manufacture of the product. These standards must be, in decreasing order of preference:

- a European standard (EN prefix)
- a European harmonisation document (HD prefix)
- an international IEC standard
- a national standard
- in the absence of reference standards, the manufacturer's internal specifications guaranteeing compliance with the basic safety requirements of the directive.

Compliance with harmonised technical standards (i.e. ratified by CENELEC) also constitutes presumed compliance with the basic safety requirements of the directives.

The CE marking of ILME products results from the declaration of conformity of the product to harmonised standards or international IEC standards.

Through the CE mark, ILME declares full compliance, not merely with the directive's basic safety requirements, but also with those international or national EU standards on which voluntary safety certification markings are based (e.g. IMQ and VDE). In this way, ILME intends to give the CE mark the value of self-certification in terms of safety, given the loss in legal value of voluntary certifications issued by third parties, ratified by directive 93/68/EEC*.

Notwithstanding the above, practically all ILME products still bear voluntary conformity markings.

This EC declaration of conformity becomes null and void when the assembly of products includes one or more components not manufactured by us and without EC approval.

* **Note:** The new legal reference for the Low Voltage Directive is 2006/95/EC which is the consolidated edition of Directive 73/23/EEC + Directive 93/68/EEC.

On 29th March 2014, the Official Gazette of the European Union published the new Low Voltage directive, 2014/35/EU of 26th February 2014, a rewritten version of directive 2006/95/EC, which will come into force on 20th April 2016.

The information contained in this catalogue is not binding and may be changed without notice



ISO 9001 certification: 2008
Design, manufacture and distribution of industrial electrical equipment (IAF 19, 29a)
Certificate No. 50 100 11133



T-TYPE enclosures

Standard & Aggressive environments,
Hygienic applications

T-TYPE STANDARD

for standard
applications



Pages 6-15

HYGIENIC T-TYPE/H

for food
& beverage

HYGIENIC T-TYPE/C

for low
temperatures



ECOLAB

Pages 26-53

T-TYPE/W

for aggressive
environments



Pages 16-25

T-TYPE General information

International standards

The T-TYPE enclosures have been successfully tested

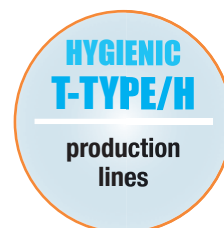

T-TYPE enclosures have been **successfully** tested in accordance with the following international standards, guaranteeing their usage for numerous applications:

- **EN 61984: Connectors - Safety requirements and tests.**
- **ANSI/UL 50 (Enclosures for Electrical Equipment)** equivalent to voluntary North American standard NEMA 250 (NEMA = National Electrical Manufacturers Association) and the corresponding Canadian standard CSA C22.2 No. 94 (Special Purpose Enclosures) for degrees of protection used in North America and required by local installation codes (e.g. NFPA 70 National Electrical Code in the USA, CSA plant standards for Canada). The current type approval was obtained after passing a number of tests carried out in accordance with the standard, in particular: **Type 12 (= NEMA 12)** for internal use, similar to degree of protection IP54 according to IEC/EN 60529. (Only standard T-TYPE enclosures).
- **EN 60529: Degrees of protection provided by enclosures (IP Code)** for ratings IP65, IP66 and IP69 (where applicable).
- **EN 62262: Degrees of protection provided by enclosures for electrical equipment against external mechanical impacts (IK Code)** for ratings IK09 (enclosures with levers), IK10 (enclosures without levers).
- **IEC 60068-2-52: Environmental testing - Part 2-52: Salt spray, cyclic:** with 5% solution of sodium chloride (NaCl), solution Ph from 6.5 to 7.2;

ENVIRONMENTAL CONDITIONS: 35 °C for 2 hours; 40 °C for 168 hours with 93% relative humidity;

NO. OF CYCLES: 4;

TEST PASSED: maintaining the IP degree of protection and with a contact resistance value \leq 150% of the initial value or \leq 5 m Ω .

- **IEC 60068-2-6: Environmental testing - Part 2-6: Vibrations (sinusoidal):** with values 10Hz+500Hz, 0.35 mm amplitude of displacement, 50m/s² (5g_r), crossover point 60.1 Hz; **NO. OF CYCLES:** 10; **TEST PASSED:** scanning 3 axes for 2 hours, with contact resistance value \leq 150% of the initial value or \leq 5 m Ω and no micro-interruption (\geq 1 μ s).
- **IEC 60068-2-3: Environmental testing - Part 2-3: Warm damp:** stationary at 40 °C, 93% relative humidity, 504 hours; **TEST PASSED:** with contact resistance value \leq 150% of the initial value or \leq 5 m Ω and no disruptive discharge (insulation resistance > 100 G Ω).
- **IEC 60068-2-30: Environmental testing - Part 2-30: Cyclic warm humid:** 40 °C, 95% relative humidity, 12 hours at ambient temperature; **NO. OF CYCLES:** 21; **TEST PASSED:** with contact resistance value \leq 150% of the initial value or \leq 5 m Ω and no disruptive discharge (insulation resistance > 100 G Ω).

T-TYPE General information

Application fields

NAVAL



OFFSHORE



ROBOTICS



AUTOMATION



SALT-SPRAYERS



T-TYPE application fields

standard applications
aggressive environments
food & beverage

POWER SUPPLIES



ELECTRIC PANELS



RADIO CONTROLS



FOOD & BEVERAGE



SAFETY SYSTEMS



T-TYPE General information

Resistance to chemicals comparison table

The classification herewith provided is only a generic reference guide in order to enable a first selection. It is based on literature data provided by the suppliers of the raw materials used, which are related to tests carried out on specimens under test conditions which are not always homogeneous and involving accelerating techniques, therefore not necessarily describing real operational conditions. The actual behaviour of products in the field may therefore be positively or negatively influenced by several

variable environmental parameters such as temperature, relative humidity, simultaneous presence of a plurality of substances and their concentration, exposure time, dynamic or static application condition, and so on. The accuracy of transferring the indications given herein to the actual conditions of use is therefore merely indicative and does not imply any guarantee or responsibility by ILME.

	T-TYPE	T-TYPE / W	T-TYPE / H	T-TYPE / C
A				
Acetone (propanone)	x	x	x	x
Active chlorine	x	x	x	x
Alum	●	●	●	●
Ammonia, 10% aqueous solution	●	x	●	●
Ammonia, liquid	x	x	●	●
Ammonium acetate	●	x	●	●
Ammonium carbonate	●	●	●	x
Ammonium chloride	●	●	●	x
Ammonium nitrate	●	●	●	●
Ammonium phosphate	●	●	●	●
Ammonium sulphate	●	●	●	●
Amyl alcohol	□	□	□	x
Aniline	□	□	x	x
Aqua regia (1:3 nitric acid : hydrochloric acid)	x	x	x	x
Asphalt	□	□	□	x
B				
Beer	●	●	●	●
Benzene	x	□	x	x
Borax	□	□	□	□
Boric acid	●	●	●	●
Boric acid, 10% aqueous solution	●	●	●	●
Boric water (boric acid 3%)	●	●	●	●
Butane, gas	□	□	□	x
Butane, liquid	□	□	□	x
C				
Calcium chloride	●	●	●	●
Calcium chloride, 10% aqueous solution	●	●	●	●
Calcium chloride, diluted suspension	●	●	●	●
Calcium nitrate	●	●	●	●
Calcium sulphate	●	●	x	●
Caustic potash (potassium hydroxide) 10%	x	●	●	x
Citric acid 50% aqueous solution	x	●	●	●
Copper sulphate 10% aqueous solution	●	●	●	●
Cresol	□	□	x	x
Cresolic solution	□	□	x	x
Cutting oil	□	□	□	x
Cyclo-hexane	□	□	□	x
D				
Deca-hydro-naphtalene	x	x	x	x
Di-exyl Phtalate	●	x	x	x

	T-TYPE	T-TYPE / W	T-TYPE / H	T-TYPE / C
D				
Di-isononyl Phtalate	●	x	x	x
Di-optyl Phtalate	●	●	x	x
Diesel Oil	□	□	□	□
Diluted Glucose	●	●	●	●
Diluted Glycerine	●	●	●	●
Diluted Glycol	●	●	●	●
Diluted Phenol	□	□	x	x
Diluted urea	●	●	●	●
E				
Ethanol (ethyl alcohol)	x	x	x	●
Ethyl alcohol	●	●	□	●
Ethylene-glycol or propylene-glycol	●	●	●	●
F				
Fatty acids	●	●	●	□
Ferric chloride, 10% aqueous solution	x	x	x	x
Formalin (formaldehyde 40% aqueous solution)	x	x	●	●
Fruit juices	●	●	●	●
Fuel oils	□	□	□	x
G				
Gaseous ammonia	□	x	●	●
Gaseous propane	x	●	●	x
Glycerine	●	●	●	●
Grinding oil	□	□	□	x
Gypsum (see calcium sulphate)	●	●	x	●
H				
Heptane	□	□	□	x
Hexane	□	□	□	x
Hydrochloric acid, <2% aqueous solution	x	●	●	□
Hydrogen sulphide	□	x	●	x
I				
Ink	●	●	●	●
IRM oil 901	●	●	●	●
IRM oil 902	□	●	●	x
IRM oil 903	x	□	□	□
Isopropyl alcohol	□	●	●	●
K				
Kitchen salt, aqueous solution	●	●	●	●

Legend

● : Resistant

□ : Limited resistance

x : Not resistant

T-TYPE General information

Resistance to chemicals comparison table

	T-TYPE	T-TYPE / W	T-TYPE / H	T-TYPE / C
L				
Lactic acid	●	●	●	●
Linseed oil	●	●	●	●
Liquid soap	x	●	●	●
Lubricating engine oil	□	□	□	x
Lubricating oil	●	●	●	x

	T-TYPE	T-TYPE / W	T-TYPE / H	T-TYPE / C
M				
Mercury	●	●	●	●
Methanol (methyl alcohol)	x	x	●	●
Methyl alcohol, diluted 50%	□	□	●	●
Mineral based oil	●	●	●	●
Mineral oils (un-tasteful)	●	●	●	●
Mothballs (naphthalene, paradichlorobenzene)	□	□	x	x
Muriatic acid, concentrated	x	□	x	x

	T-TYPE	T-TYPE / W	T-TYPE / H	T-TYPE / C
N				
n-Butanol (butyl alcohol)	●	●	●	●
Naphthalene	□	●	x	x
Normal (low octane) gasoline (petrol)	□	□	□	x

	T-TYPE	T-TYPE / W	T-TYPE / H	T-TYPE / C
O				
Octane	□	□	□	x
Oleic acid	●	●	●	x
Oxalic acid	●	●	●	●
Ozone	x	□	x	□

	T-TYPE	T-TYPE / W	T-TYPE / H	T-TYPE / C
P				
Paraffin oil	●	●	●	●
Petrol ether	□	□	□	□
Petroleum	●	●	●	●
Petroleum spirit (dry cleaning)	□	□	x	x
Potassium carbonate	●	●	●	●
Potassium chlorate	●	●	x	●
Potassium chloride	●	●	●	●
Potassium cyanide, aqueous solution	●	●	●	●
Potassium di-chromate	□	●	●	●
Potassium iodide	□	●	●	●
Potassium nitrate	□	x	x	●
Potassium persulphate	□	●	x	●
Potassium sulphate	□	●	●	●

	T-TYPE	T-TYPE / W	T-TYPE / H	T-TYPE / C
S				
Sea water	●	●	●	●
Silicon oil	●	●	●	x
Soap solution	□	●	●	●
Sodium bicarbonate (oxide)	●	●	●	●
Sodium carbonate (washing soda)	●	●	●	●
Sodium chlorate	●	●	x	●
Sodium chloride (kitchen salt)	●	●	●	●

	T-TYPE	T-TYPE / W	T-TYPE / H	T-TYPE / C
S				
Sodium disulphate, aqueous solution	●	●	●	●
Sodium hydroxide (caustic soda)	x	x	●	●
Sodium hydroxide 12,5% (liscivia)	□	x	●	●
Sodium Hypochlorite	x	●	●	●
Sodium nitrate	●	●	●	x
Sodium nitrite	□	●	●	x
Sodium perborate	●	●	●	●
Sodium phosphate	●	●	●	x
Sodium silicate	●	x	x	●
Sodium sulphate	●	●	●	●
Sodium sulphide	●	●	●	●
Sodium Thiosulphate (photographic fixer)	●	●	●	●
Solution for photographic processing	●	●	●	●
Starch, aqueous (amylum)	●	●	●	●
Stearic acid	●	●	●	●
Succinic acid (butanedioic acid)	●	●	●	●
Sulphur	●	●	x	x
Sulphur dioxide (sulphurous anhydride)	□	x	x	□
Sulphuric acid, 2% aqueous solution	x	□	□	□

	T-TYPE	T-TYPE / W	T-TYPE / H	T-TYPE / C
T				
Tallow	●	●	●	●
Tar	□	□	x	□
Tartaric acid	●	●	●	●
Toluene	x	x	x	x
Transformer oil (dielectric)	●	●	●	●
Trichloroethylene	x	x	x	x
Trichresyl phosphate	●	●	x	x
Turpentine essence	x	□	□	x

	T-TYPE	T-TYPE / W	T-TYPE / H	T-TYPE / C
U				
Urine	●	●	●	●

	T-TYPE	T-TYPE / W	T-TYPE / H	T-TYPE / C
V				
Vegetable oil	●	●	●	●
Vinegar	x	●	●	□

	T-TYPE	T-TYPE / W	T-TYPE / H	T-TYPE / C
W				
Water	●	●	●	●
White alcohol (isopropanol + ethanol)	□	●	●	●

	T-TYPE	T-TYPE / W	T-TYPE / H	T-TYPE / C
X				
Xylene	x	x	x	x

Legend ● : Resistant

□ : Limited resistance

x : Not resistant

T-TYPE Standard

For modular and standard inserts

T-TYPE insulating enclosures for standard applications

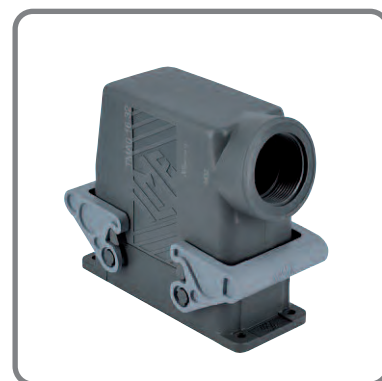

Alongside the wide range of traditional metallic enclosures for ILME multipole connectors, there is now available a **new series of enclosures in self-extinguishing thermoplastic material** in the most common sizes “44.27”, “57.27”, “77.27” and “104.27”.

Quality and money saving are the main features of these enclosures, as an outcome of careful product studies.

Valuable characteristics of these new versions of enclosures:

- **significant structural solidity** and mechanical robustness by virtue of **substantial thickness**;

- **external dimensions** of the bulkhead mounting housings are **similar to those of the corresponding metallic enclosures**;
- **hole fixing centres are unchanged**;
- **pre-fastened gaskets** for easier installation;
- **wide space inside the enclosures** for cables, with mounted connector inserts, similar to the corresponding “high construction” versions;
- possibility of making **total insulation** constructions (equivalent to Class II) ☐ ;
- **absence of powder paint** for environments in which these are not recommended (e.g. to avoid food contamination).

T-TYPE STANDARD

STANDARD APPLICATIONS

DATA SHEETS AT PAGES 8-15

- › Enclosures in **thermoplastic material, dark grey RAL 7012 colour**, with high thicknesses providing structural solidity and durability.
- › Built-in **polyurethane gaskets**.
- › **Locking levers** in **thermoplastic material colour grey RAL 7001**.
- › **M25, M32 and M40** threaded cable entries.
- › **IP65** degree of protection according to **EN 60529**;
- › **UL TYPE 12** degree of protection according to **ANSI/UL50**.
- › Each enclosure carries its own part number, thread/size, conformity **markings** and UL type rating.
- › Ambient temperature range: **-40 °C / +90 °C**.

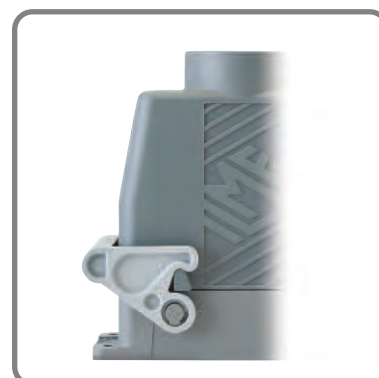

T-TYPE Standard

For modular and standard inserts

FOCUS ON:

1 Construction

By using the BC-MUL® moulding technique and use of MIL.BOX® material, **these enclosures are structurally solid and mechanically robust**, due to their increased thickness. They are particularly resistant to the main pollutants present in industrial environments. The lever enclosure pegs are built into the enclosures. The methods for fastening the connector inserts to the enclosures are made of M3 threaded metal inserts.

With reference to metal construction enclosures, which to comply with the electrical installation safety norms, must be earthed via a metal connection to the grounding terminal of the inserts mounted inside the enclosures, the new series of enclosures offers a solution for **total insulation** constructions (equivalent to class II) where necessary. The thermoplastic material used is RAL 7012 dark grey colour and UL 94V-2 grade self-extinguishing and has passed glow wire testing in accordance with the IEC (EN) 60695-2-11 at 650 °C in compliance with intended uses.

The **surface mounting** high construction housings are supplied **with an open threaded entry** and diametrically opposite a closed threaded entry, which can be **opened** by the user, if required (with suitable tool).

Manufactured from insulating material, they do not require **special reinforced insulation** as the metal versions do, for use with series **CME higher voltage** connector inserts (screw-type terminals).

2 Gaskets

T-Type standard sealing gaskets have been produced by means of the FIPFG technology (Formed-In-Place-Foam-Gasket). They have therefore been incorporated in the base flange on bulkhead mounting housings for easier installation.

- T-Type standard: Built-in polyurethane gaskets
- T-Type/W: Viton fluoroelastomer gaskets

3 Levers

The locking levers have been produced in self-extinguishing thermoplastic material, grey RAL 7001 colour.

4 Dimensions

The internal dimensions allow mounting of all connector inserts in their relevant sizes. The external dimensions of the bulkhead mounting housings are similar to those of the corresponding metallic enclosures; hole fixing centres are unchanged.

Hoods offer an inner cabling space similar to that of the “high” construction models of the corresponding metal enclosures. Other characteristics are in compliance with the applicable safety standard for electrical connectors, IEC/EN 61984.

5 Cable entries

The housing and hood cable entries are available with metric thread, respectively:

- **M25 or M32** for smaller sizes “44.27” and “57.27”.
- **M32 or M40** for larger sizes “77.27” and “104.27”.

The recent standard IEC/EN 61076-7-100 regarding metric cable entries for multipole electrical connectors for heavy duty uses, which standardises some main dimensions for entries and their related accessories (gaskets, pressure nuts), have been carefully considered in the product design.

6 Markings

Each enclosure carries its own part number and conformity markings.

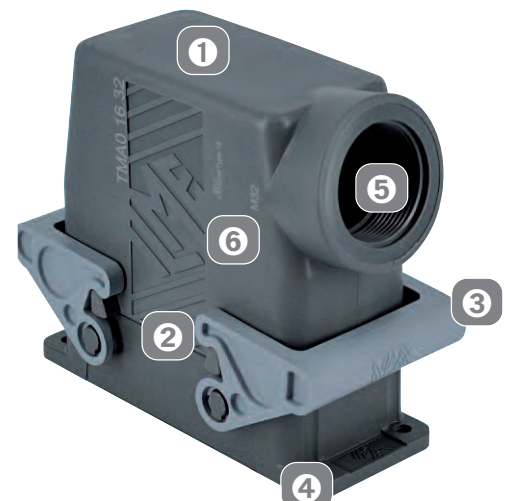



inserts:	page:
CDD 24 poles + ⊕	59 *
CQE 10 poles + ⊕	80 *
CSH 6 poles + ⊕	88 *
CCE 6 poles + ⊕	94 *
CNE, CSE 6 poles + ⊕	95 *
CSS 6 poles + ⊕	118 *
CT, CTE, CTSE *) .. 6 poles + ⊕	126 and 130 *
MIXO 2 modules	156-195 *
CDS 9 poles + ⊕	6 **

*) only for standard insulating version TCHI

* refer to CN.12 catalogue page

** refer to CDS catalogue page

insert centre distance:
44 x 27 mm

housings with single lever



hoods with 2 pegs



description	part No.	entry M
bulkhead mounting housing with thermoplastic lever	TCHI 06 L	
surface mounting housing with thermoplastic lever	TMAP 06 L25	25
surface mounting housing with thermoplastic lever	TMAP 06 L32	32
with pegs, side entry		
with pegs, side entry		
with pegs, top entry		
with pegs, top entry		

part No.	entry M

part No.	entry M
TMAO 06 L25	25
TMAO 06 L32	32
TMAV 06 L25	25
TMAV 06 L32	32

panel cut-out for bulkhead mounting housing in mm

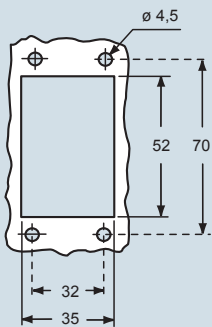

dimensions in mm

TCHI 06 L

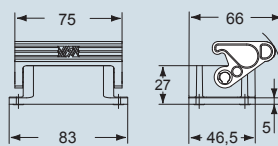

dimensions in mm

TMAO 06 L25 and TMAO 06 L32

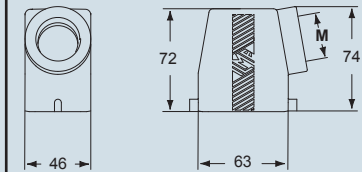

TMAP 06 L25 and TMAP 06 L32

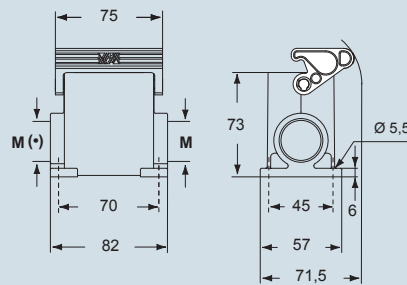

TMAV 06 L25 and TMAV 06 L32

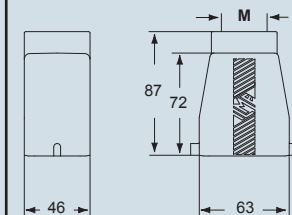

(+) The surface mounting, high construction housings are supplied with an open threaded entry (+) and diametrically opposite a closed threaded entry which can be opened by the user if required (with suitable tool).



- ambient temperature limits -40 °C / +90 °C.

dimensions shown are not binding and may be changed without notice

inserts:	page:
CDD 24 poles + ⊕	59 *
CQE 10 poles + ⊕	80 *
CSH 6 poles + ⊕	88 *
CCE 6 poles + ⊕	94 *
CNE, CSE 6 poles + ⊕	95 *
CSS 6 poles + ⊕	118 *
CT, CTE, CTSE *) .. 6 poles + ⊕	126 and 130 *
MIXO 2 modules	156-195 *
CDS 9 poles + ⊕	6 **

*) only for standard insulating version TCHI

* refer to CN.12 catalogue page

** refer to CDS catalogue page

insert centre distance:
44 x 27 mm

hoods with single lever top entry



covers



description	part No.	entry M	part No.
with thermoplastic lever and gasket	TMAV 06 LG25	25	
with thermoplastic lever and gasket	TMAV 06 LG32	32	
with pegs			TCHC 06 L
with thermoplastic lever and gasket			TCHC 06 LG

dimensions in mm

TMAV 06 LG25 and TMAV 06 LG32

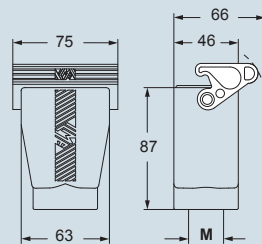

dimensions in mm

TCHC 06 L

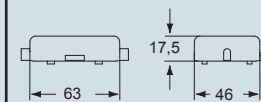

TCHC 06 LG

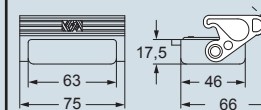

CAVUS® Type 12



- ambient temperature limits -40 °C / +90 °C.

dimensions shown are not binding
and may be changed without notice



inserts:	page:
CDD 42 poles + ⊕	61 *
CQE 18 poles + ⊕	81 *
CSH 10 poles + ⊕	89 *
CCE 10 poles + ⊕	96 *
CNE, CSE 10 poles + ⊕	97 *
CSS 10 poles + ⊕	119 *
CT, CTE, CTSE * 10 poles + ⊕	127 and 131 *
CMSE 3+2 (aux) poles + ⊕	135 *
CMCE 3+2 (aux) poles + ⊕	134 *
CME 3+2 (aux) poles + ⊕	135 *
CX 8/24 poles + ⊕	151 *
MIXO 3 modules	156-195 *
CDS 18 poles + ⊕	7 **

*) only for standard insulating version TCHI

* refer to CN.12 catalogue page

** refer to CDS catalogue page

insert centre distance: 57 x 27 mm

housings with double lever



hoods with 4 pegs



description	part No.	entry M
bulkhead mounting housing with thermoplastic levers	TCHI 10	
surface mounting housing with thermoplastic levers	TMAP 10.25	25
surface mounting housing with thermoplastic levers	TMAP 10.32	32
with pegs, side entry		
with pegs, side entry		
with pegs, top entry		
with pegs, top entry		

part No.	entry M
TMAO 10.25	25
TMAO 10.32	32
TMAV 10.25	25
TMAV 10.32	32

panel cut-out for bulkhead mounting housing in mm

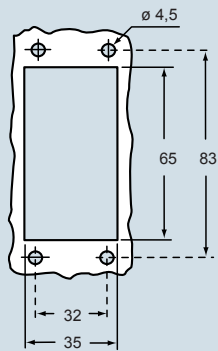

dimensions in mm

TCHI 10

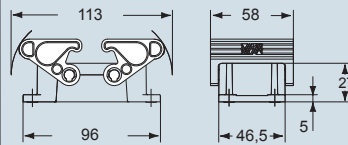

dimensions in mm

TMAO 10.25 and TMAO 10.32

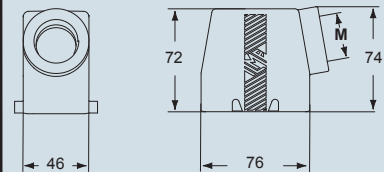

TMAP 10.25 and TMAP 10.32

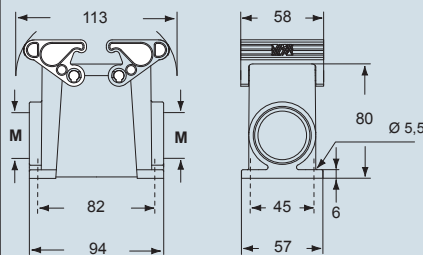

TMAV 10.25 and TMAV 10.32

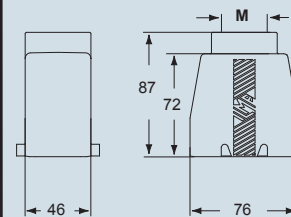

The surface mounting, high construction housings are supplied with an open threaded entry and diametrically opposite a closed threaded entry which can be opened by the user if required (with suitable tool).

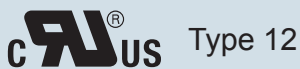

- ambient temperature limits -40 °C / +90 °C.

dimensions shown are not binding and may be changed without notice

inserts:	page:	
CDD 42 poles + ⊕	61 *	
CQE 18 poles + ⊕	81 *	
CSH 10 poles + ⊕	89 *	
CCE 10 poles + ⊕	96 *	
CNE, CSE 10 poles + ⊕	97 *	
CSS 10 poles + ⊕	119 *	
CT, CTE, CTSE *) 10 poles + ⊕	127 and 131 *	
CMSE 3+2 (aux) poles + ⊕	135 *	
CMCE 3+2 (aux) poles + ⊕	134 *	
CME 3+2 (aux) poles + ⊕	135 *	
CX 8/24 poles + ⊕	151 *	
MIXO 3 modules	156-195 *	
CDS 18 poles + ⊕	7 **	

*) only for standard insulating version TCHI

* refer to CN.12 catalogue page

** refer to CDS catalogue page

insert centre distance: **57 x 27 mm**

hoods with double lever top entry



covers



description	part No.	entry M	part No.
with thermoplastic levers and gasket	TMAV 10 G25	25	
with thermoplastic levers and gasket	TMAV 10 G32	32	
with 4 pegs			TCHC 10
with 2 thermoplastic levers and gasket			TCHC 10 G

dimensions in mm

TMAV 10 G25 and TMAV 10 G32

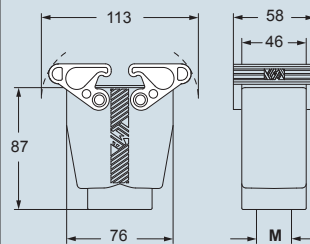

dimensions in mm

TCHC 10

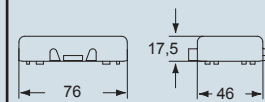

TCHC 10 G

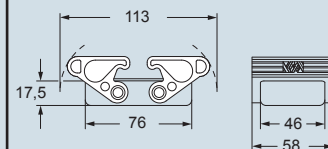

CAIUS® Type 12



- ambient temperature limits -40 °C / +90 °C.

dimensions shown are not binding and may be changed without notice



inserts:		page:
CD	40 poles + ⊕	49 *
CDD	72 poles + ⊕	62 *
CQE	32 poles + ⊕	82 *
CSH	16 poles + ⊕	90 *
CCE	16 poles + ⊕	98 *
CNE, CSE	16 poles + ⊕	99 *
CSS	16 poles + ⊕	120 *
CT, CTE, CTSE *) ..	16 poles + ⊕ 128 and 132 *	132 *
CME, CMSE 6+2 (aux)	poles + ⊕	137 *
CMCE	6+2 (aux) poles + ⊕	136 *
CP	6 poles + ⊕	149 *
CX	6/36 and 12/2 poles + ⊕	152-153 *
CX	4/0 and 4/2 poles + ⊕	154 *
MIXO	4 modules	156-195 *
CDS	27 poles + ⊕	8 **
CQEE	40 poles + ⊕	15 ***

*) only for standard insulating version TCHI
 * refer to CN.12 catalogue page
 ** refer to CDS catalogue page
 *** refer to Supplement October 2013 catalogue page
 insert centre distance: 77,5 x 27 mm

housings with double lever

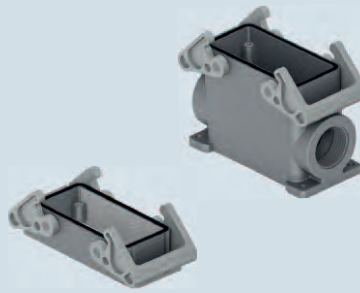

hoods with 4 pegs



description	part No.	entry M
bulkhead mounting housing with thermoplastic levers	TCHI 16	
surface mounting housing with thermoplastic levers	TMAP 16.32	32
surface mounting housing with thermoplastic levers	TMAP 16.40	40
with pegs, side entry		
with pegs, side entry		
with pegs, top entry		
with pegs, top entry		

part No.	entry M

part No.	entry M
TMAO 16.32	32
TMAO 16.40	40
TMAV 16.32	32
TMAV 16.40	40

panel cut-out for bulkhead mounting housing in mm

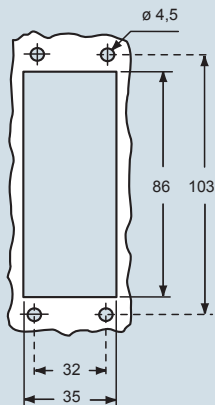

dimensions in mm

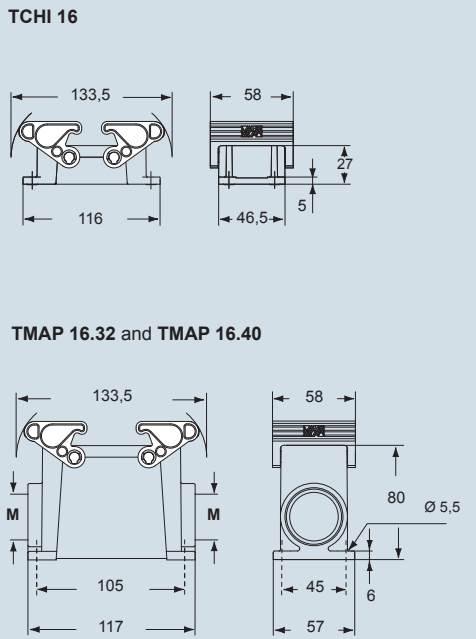

dimensions in mm

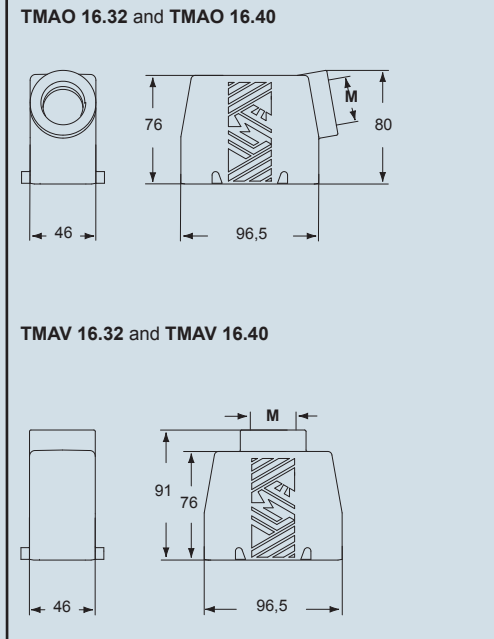

The surface mounting, high construction housings are supplied with an open threaded entry and diametrically opposite a closed threaded entry which can be opened by the user if required (with suitable tool).



- ambient temperature limits -40 °C / +90 °C.

dimensions shown are not binding and may be changed without notice

inserts:		page:
CD	40 poles + ⊕	49 *
CDD	72 poles + ⊕	62 *
CQE	32 poles + ⊕	82 *
CSH	16 poles + ⊕	90 *
CCE	16 poles + ⊕	98 *
CNE, CSE	16 poles + ⊕	99 *
CSS	16 poles + ⊕	120 *
CT, CTE, CTSE *) ..	16 poles + ⊕ 128 and 132 *	
CME, CMSE 6+2 (aux)	poles + ⊕	137 *
CMCE	6+2 (aux) poles + ⊕	136 *
CP	6 poles + ⊕	149 *
CX	6/36 and 12/2 poles + ⊕	152-153 *
CX	4/0 and 4/2 poles + ⊕	154 *
MIXO	4 modules	156-195 *
CDS	27 poles + ⊕	8 **
CQEE	40 poles + ⊕	15 ***

*) only for standard insulating version TCHI
 * refer to CN.12 catalogue page
 ** refer to CDS catalogue page
 *** refer to Supplement October 2013 catalogue page
 insert centre distance: 77,5 x 27 mm

hoods with double lever top entry



covers



description	part No.	entry M	part No.
with thermoplastic levers and gasket	TMAV 16 G32	32	
with thermoplastic levers and gasket	TMAV 16 G40	40	
with 4 pegs			TCHC 16
with 2 thermoplastic levers and gasket			TCHC 16 G

dimensions in mm

TMAV 16 G32 and TMAV 16 G40

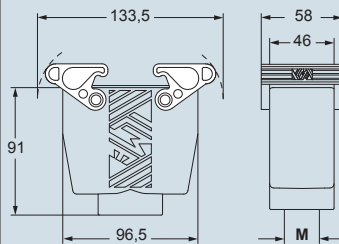

dimensions in mm

TCHC 16

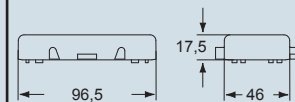

TCHC 16 G

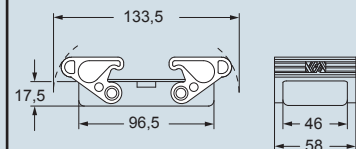

CAIUS Type 12



- ambient temperature limits -40 °C / +90 °C.

dimensions shown are not binding and may be changed without notice



inserts:		page:
CD	64 poles + ⊕	51 *
CDD	108 poles + ⊕	64 *
CQE	46 poles + ⊕	83 *
CSH	24 poles + ⊕	91 *
CCE	24 poles + ⊕	100 *
CNE, CSE	24 poles + ⊕	101 *
CSS	24 poles + ⊕	121 *
CT, CTE, CTSE *)	24 poles + ⊕	129 and 133 *
CME, CMSE 10+2 (aux)	poles + ⊕	139 *
CMCE	10+2 (aux) poles + ⊕	138 *
CME	16+2 (aux) poles + ⊕	145 *
CMCE	16+2 (aux) poles + ⊕	144 *
CX	4/8 poles + ⊕	155 *
MIXO	6 modules	156-195 *
CDS	42 poles + ⊕	9 **
CQEE	64 poles + ⊕	16 ***

*) only for standard insulating version TCHI
 * refer to CN.12 catalogue page
 ** refer to CDS catalogue page
 *** refer to Supplement October 2013 catalogue page
 insert centre distance: 104 x 27 mm

housings with double lever

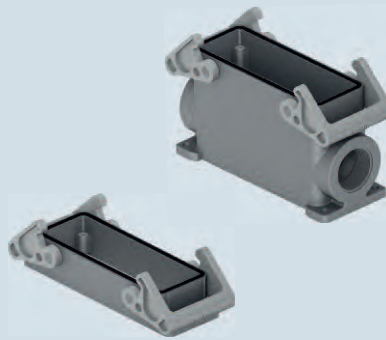

hoods with 4 pegs



description	part No.	entry M	part No.	entry M
bulkhead mounting housing with thermoplastic levers	TCHI 24			
surface mounting housing with thermoplastic levers	TMAP 24.32	32		
surface mounting housing with thermoplastic levers	TMAP 24.40	40		
with pegs, side entry			TMAO 24.32	32
with pegs, side entry			TMAO 24.40	40
with pegs, top entry			TMAV 24.32	32
with pegs, top entry			TMAV 24.40	40

panel cut-out for bulkhead mounting housing in mm

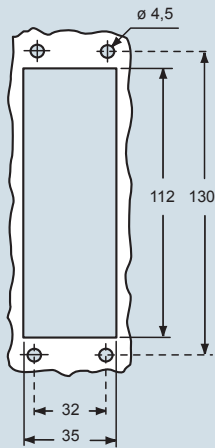

dimensions in mm

TCHI 24

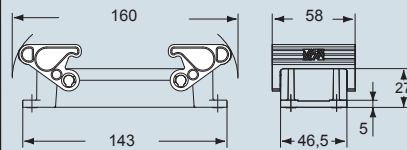

TMAP 24.32 and TMAP 24.40

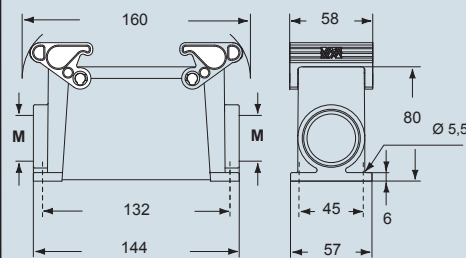

dimensions in mm

TMAO 24.32 and TMAO 24.40

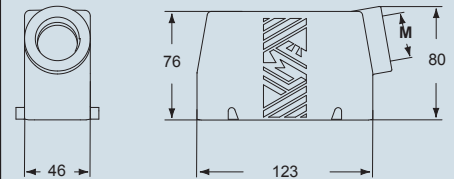

TMAV 24.32 and TMAV 24.40

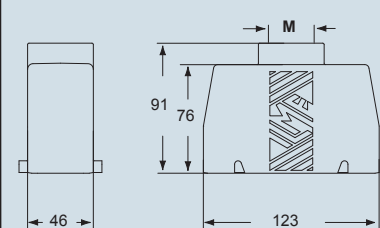

The surface mounting, high construction housings are supplied with an open threaded entry and diametrically opposite a closed threaded entry which can be opened by the user if required (with suitable tool).

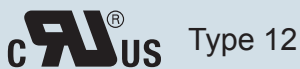

- ambient temperature limits -40 °C / +90 °C.

dimensions shown are not binding and may be changed without notice

inserts:		page:
CD	64 poles + ⊕	51 *
CDD	108 poles + ⊕	64 *
CQE	46 poles + ⊕	83 *
CSH	24 poles + ⊕	91 *
CCE	24 poles + ⊕	100 *
CNE, CSE	24 poles + ⊕	101 *
CSS	24 poles + ⊕	121 *
CT, CTE, CTSE *)	24 poles + ⊕	129 and 133 *
CME, CMSE 10+2 (aux)	poles + ⊕	139 *
CMCE	10+2 (aux) poles + ⊕	138 *
CME	16+2 (aux) poles + ⊕	145 *
CMCE	16+2 (aux) poles + ⊕	144 *
CX	4/8 poles + ⊕	155 *
MIXO	6 modules	156-195 *
CDS	42 poles + ⊕	9 **
CQEE	64 poles + ⊕	16 ***

*) only for standard insulating version TCHI
 * refer to CN.12 catalogue page
 ** refer to CDS catalogue page
 *** refer to Supplement October 2013 catalogue page
 insert centre distance: **104 x 27 mm**

hoods with double lever top entry



covers



description	part No.	entry M
with thermoplastic levers and gasket	TMAV 24 G32	32
with thermoplastic levers and gasket	TMAV 24 G40	40
with 4 pegs		
with 2 thermoplastic levers and gasket		

part No.	
TCHC 24	
TCHC 24 G	

dimensions in mm

TMAV 24 G32 and TMAV 24 G40

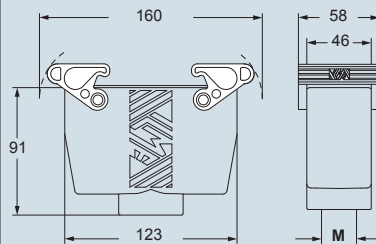

dimensions in mm

TCHC 24

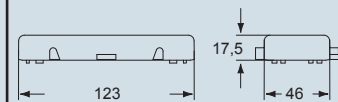

TCHC 24 G

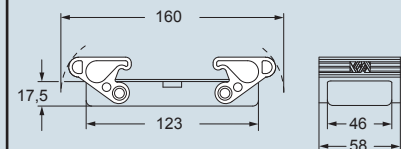

CAIUS Type 12



- ambient temperature limits -40 °C / +90 °C.

dimensions shown are not binding and may be changed without notice

T-TYPE / W

Aggressive environments

- › Enclosures in **thermoplastic material, dark grey RAL 7012 colour**, with high thicknesses providing structural solidity and durability.
- › Built-in **VITON fluoroelastomer sealing gaskets**.
- › **Locking levers** in thermoplastic material colour grey **RAL 7001**.
- › **M25, M32 and M40** threaded cable entries.
- › **IP66** degree of protection according to **EN 60529**.
- › Each enclosure carries its own part number, thread size and conformity **markings**.
- › Ambient temperature range: **-40 °C / +90 °C**.

NOTE: As the characterizing element of the T-TYPE/W series is the **different sealing gasket** material, hoods and covers without sealing gaskets for these series are the same of T-Type Standard.

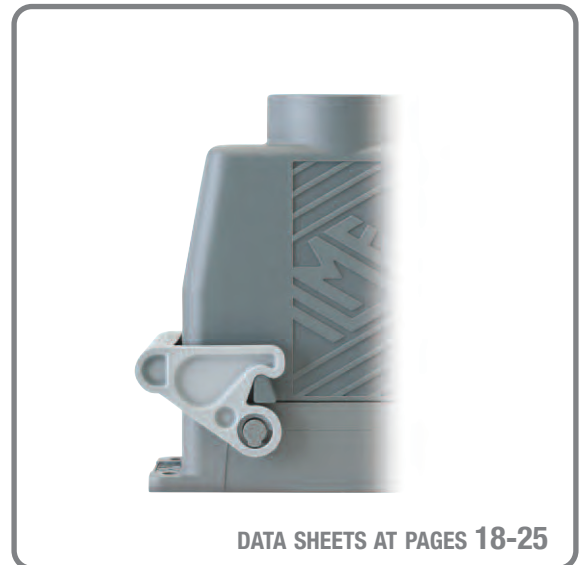

T-TYPE / W - For aggressive environments

T-TYPE/W

IP66
for aggressive environments

OFFSHORE



NAVAL



SALT-SPRAYERS



T-TYPE / W

Featuring an original design, T-TYPE/W construction types available are:

surface mounting housings

with double entry of which one closed but threaded



hoods

with levers



bulkhead mounting housings



hoods

with side entry



hoods

with top entry



covers

with pegs (for housings) with levers (for hoods)



single lever, side and top entry,
for size "44.27"



single lever, side and top entry,
for size "44.27"



double lever, side and top entry,
for other sizes "57.27, 77.27, 104.27"



double lever, side and top entry,
for other sizes "57.27, 77.27, 104.27"

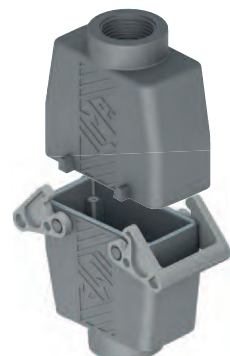



inserts:	page:
CDD 24 poles + ⊕	59 *
CQE 10 poles + ⊕	80 *
CSH 6 poles + ⊕	88 *
CCE 6 poles + ⊕	94 *
CNE, CSE 6 poles + ⊕	95 *
CSS 6 poles + ⊕	118 *
CT, CTE, CTSE *) .. 6 poles + ⊕	126 and 130 *
MIXO 2 modules	156-195 *
CDS 9 poles + ⊕	6 **

*) only for standard insulating version THIW

* refer to CN.12 catalogue page
 ** refer to CDS catalogue page

insert centre distance:
44 x 27 mm

housings with single lever



VITON gasket

hoods with 2 pegs



description	part No.	entry M
bulkhead mounting housing with thermoplastic levers	THIW 06 L	
surface mounting housing with thermoplastic levers	TAPW 06 L25	25
surface mounting housing with thermoplastic levers	TAPW 06 L32	32
with pegs, side entry		
with pegs, side entry		
with pegs, top entry		
with pegs, top entry		

description	part No.	entry M
bulkhead mounting housing with thermoplastic levers	THIW 06 L	
surface mounting housing with thermoplastic levers	TAPW 06 L25	25
surface mounting housing with thermoplastic levers	TAPW 06 L32	32
with pegs, side entry		
with pegs, side entry		
with pegs, top entry		
with pegs, top entry		

description	part No.	entry M
bulkhead mounting housing with thermoplastic levers	THIW 06 L	
surface mounting housing with thermoplastic levers	TAPW 06 L25	25
surface mounting housing with thermoplastic levers	TAPW 06 L32	32
with pegs, side entry		
with pegs, side entry		
with pegs, top entry		
with pegs, top entry		

panel cut-out for bulkhead mounting housing in mm

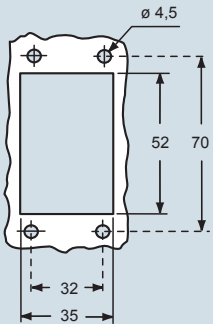

dimensions in mm

THIW 06 L

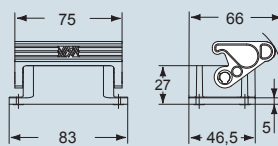

TAPW 06 L25 and TAPW 06 L32

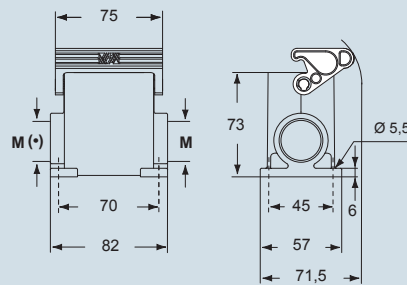

(*) The surface mounting, high construction housings are supplied with an open threaded entry (*) and diametrically opposite a closed threaded entry which can be opened by the user if required (with suitable tool).

dimensions in mm

TMAO 06 L25 and TMAO 06 L32

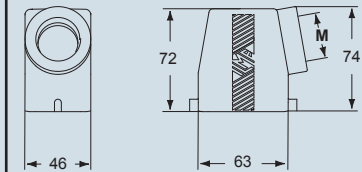

TMAV 06 L25 and TMAV 06 L32

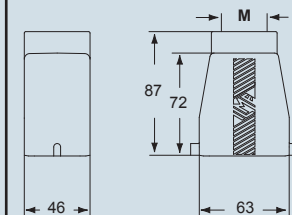

- ambient temperature limits -40 °C/+90 °C

dimensions shown are not binding and may be changed without notice

inserts:		page:
CDD	24 poles + ⊕	59 *
CQE	10 poles + ⊕	80 *
CSH	6 poles + ⊕	88 *
CCE	6 poles + ⊕	94 *
CNE, CSE	6 poles + ⊕	95 *
CSS	6 poles + ⊕	118 *
CT, CTE, CTSE *) ..	6 poles + ⊕	126 and 130 *
MIXO	2 modules	156-195 *
CDS	9 poles + ⊕	6 **

*) only for standard insulating version THIW

* refer to CN.12 catalogue page

** refer to CDS catalogue page

insert centre distance:
44 x 27 mm

hoods with single lever top entry



VITON gasket

covers



VITON gasket

description	part No.	entry M	part No.
with thermoplastic lever and gasket	TAVW 06 LG25	25	
with thermoplastic lever and gasket	TAVW 06 LG32	32	
with pegs			TCHC 06 L
with thermoplastic lever and gasket			THCW 06 LG

dimensioni in mm

TAVW 06 LG25 e TAVW 06 LG32

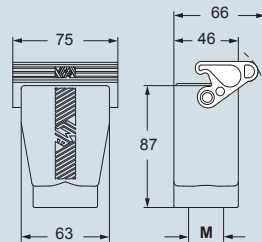

dimensioni in mm

TCHC 06 L

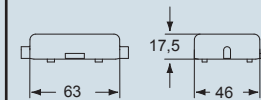

THCW 06 LG

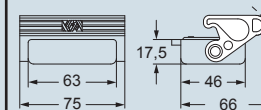

- ambient temperature limits -40 °C/+90 °C

dimensions shown are not binding and may be changed without notice



inserts:	page:
CDD 42 poles + ⊕	61 *
CQE 18 poles + ⊕	81 *
CSH 10 poles + ⊕	89 *
CCE 10 poles + ⊕	96 *
CNE, CSE 10 poles + ⊕	97 *
CSS 10 poles + ⊕	119 *
CT, CTE, CTSE *) 10 poles + ⊕	127 and 131 *
CMSE 3+2 (aux) poles + ⊕	135 *
CMCE 3+2 (aux) poles + ⊕	134 *
CME 3+2 (aux) poles + ⊕	135 *
CX 8/24 poles + ⊕	151 *
MIXO 3 modules	156-195 *
CDS 18 poles + ⊕	7 **

*) only for standard insulating version THIW
 * refer to CN.12 catalogue page
 ** refer to CDS catalogue page

insert centre distance: 57 x 27 mm

housings with double lever

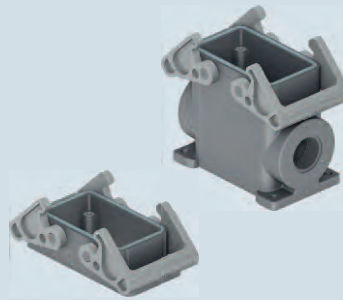

VITON gasket

hoods with 4 pegs



description	part No.	entry M	part No.	entry M
bulkhead mounting housing with thermoplastic levers	THIW 10			
surface mounting housing with thermoplastic levers	TAPW 10.25	25		
surface mounting housing with thermoplastic levers	TAPW 10.32	32		
with pegs, side entry			TMAO 10.25	25
with pegs, side entry			TMAO 10.32	32
with pegs, top entry			TMAV 10.25	25
with pegs, top entry			TMAV 10.32	32

panel cut-out for bulkhead mounting housing in mm

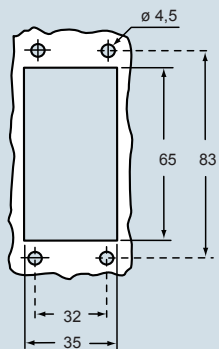

dimensions in mm

THIW 10

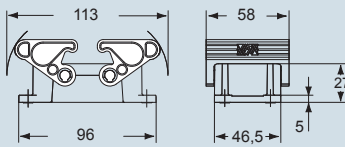

TAPW 10.25 and TAPW 10.32

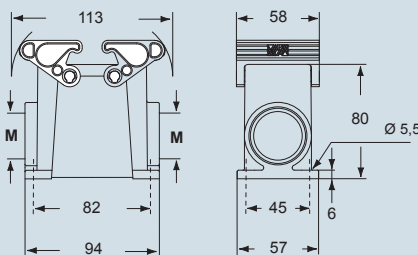

dimensions in mm

TMAO 10.25 and TMAO 10.32

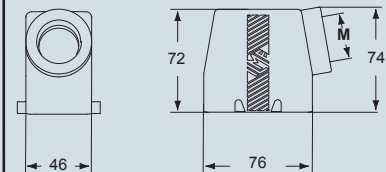

TMAV 10.25 and TMAV 10.32

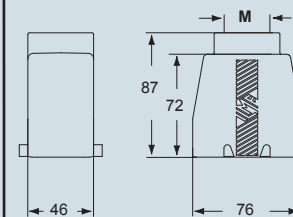

The surface mounting, high construction housings are supplied with an open threaded entry and diametrically opposite a closed threaded entry which can be opened by the user if required (with suitable tool).



- ambient temperature limits -40 °C/+90 °C

dimensions shown are not binding and may be changed without notice

inserts:		page:
CDD	42 poles + ⊕	61 *
CQE	18 poles + ⊕	81 *
CSH	10 poles + ⊕	89 *
CCE	10 poles + ⊕	96 *
CNE, CSE	10 poles + ⊕	97 *
CSS	10 poles + ⊕	119 *
CT, CTE, CTSE *)	10 poles + ⊕	127 and 131 *
CMSE	3+2 (aux) poles + ⊕	135 *
CMCE	3+2 (aux) poles + ⊕	134 *
CME	3+2 (aux) poles + ⊕	135 *
CX	8/24 poles + ⊕	151 *
MIXO	3 modules	156-195 *
CDS	18 poles + ⊕	7 **

*) only for standard insulating version THIW

* refer to CN.12 catalogue page

** refer to CDS catalogue page

insert centre distance: **57 x 27 mm**

hoods with double lever top entry



VITON gasket

covers



VITON gasket

description	part No.	entry M	part No.
with thermoplastic levers and gasket	TAVW 10 G25	25	
with thermoplastic levers and gasket	TAVW 10 G32	32	
with 4 pegs			TCHC 10
with 2 thermoplastic levers and gasket			THCW 10 G

dimensions in mm

TAVW 10 G25 and TAVW 10 G32

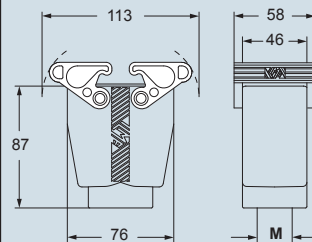

dimensions in mm

TCHC 10

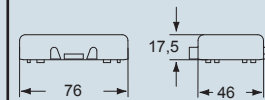

THCW 10 G

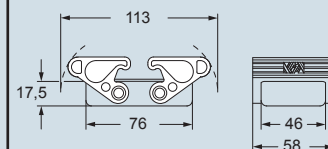

- ambient temperature limits -40 °C/+90 °C

dimensions shown are not binding and may be changed without notice



inserts:		page:
CD	40 poles + ⊕	49 *
CDD	72 poles + ⊕	62 *
CQE	32 poles + ⊕	82 *
CSH	16 poles + ⊕	90 *
CCE	16 poles + ⊕	98 *
CNE, CSE	16 poles + ⊕	99 *
CSS	16 poles + ⊕	120 *
CT, CTE, CTSE *) ..	16 poles + ⊕ 128 and 132 *	132 *
CME, CMSE 6+2 (aux)	poles + ⊕	137 *
CMCE	6+2 (aux) poles + ⊕	136 *
CP	6 poles + ⊕	149 *
CX	6/36 and 12/2 poles + ⊕	152-153 *
CX	4/0 and 4/2 poles + ⊕	154 *
MIXO	4 modules	156-195 *
CDS	27 poles + ⊕	8 **
CQEE	40 poles + ⊕	15 ***

*) only for standard insulating version THIW

* refer to CN.12 catalogue page

** refer to CDS catalogue page

*** refer to Supplement October 2013 catalogue page

insert centre distance: 77,5 x 27 mm

housings with double lever

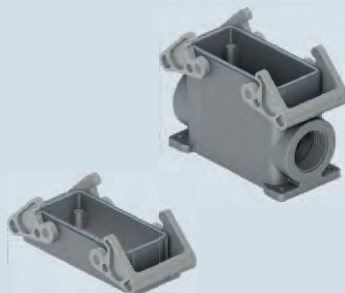

VITON gasket

hoods with 4 pegs



description	part No.	entry M
bulkhead mounting housing with thermoplastic levers	THIW 16	
surface mounting housing with thermoplastic levers	TAPW 16.32	32
surface mounting housing with thermoplastic levers	TAPW 16.40	40
with pegs, side entry		
with pegs, side entry		
with pegs, top entry		
with pegs, top entry		

description	part No.	entry M
with pegs, side entry	TMAO 16.32	32
with pegs, side entry	TMAO 16.40	40
with pegs, top entry	TMAV 16.32	32
with pegs, top entry	TMAV 16.40	40

description	part No.	entry M
with pegs, side entry	TMAO 16.32	32
with pegs, side entry	TMAO 16.40	40
with pegs, top entry	TMAV 16.32	32
with pegs, top entry	TMAV 16.40	40

panel cut-out for bulkhead mounting housing in mm

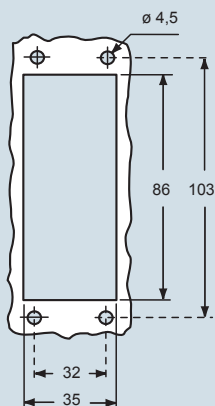

dimensions in mm

THIW 16

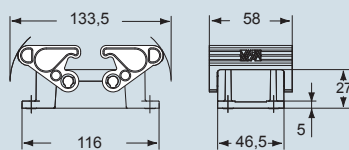

TAPW 16.32 and TAPW 16.40

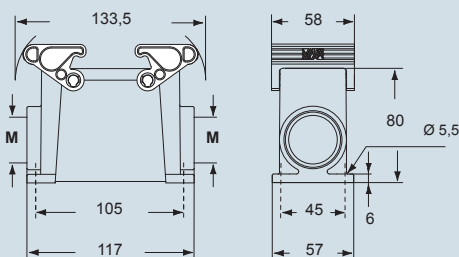

dimensions in mm

TMAO 16.32 and TMAO 16.40

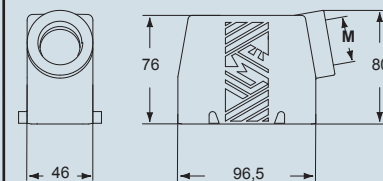

TMAV 16.32 and TMAV 16.40

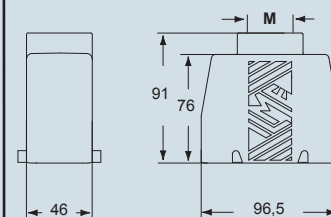

The surface mounting, high construction housings are supplied with an open threaded entry and diametrically opposite a closed threaded entry which can be opened by the user if required (with suitable tool).



- ambient temperature limits -40 °C/+90 °C

dimensions shown are not binding and may be changed without notice

inserts:		page:
CD	40 poles + ⊕	49 *
CDD	72 poles + ⊕	62 *
CQE	32 poles + ⊕	82 *
CSH	16 poles + ⊕	90 *
CCE	16 poles + ⊕	98 *
CNE, CSE	16 poles + ⊕	99 *
CSS	16 poles + ⊕	120 *
CT, CTE, CTSE *) ..	16 poles + ⊕ 128 and 132 *	
CME, CMSE 6+2 (aux)	poles + ⊕	137 *
CMCE	6+2 (aux) poles + ⊕	136 *
CP	6 poles + ⊕	149 *
CX	6/36 and 12/2 poles + ⊕	152-153 *
CX	4/0 and 4/2 poles + ⊕	154 *
MIXO	4 modules	156-195 *
CDS	27 poles + ⊕	8 **
CQEE	40 poles + ⊕	15 ***

*) only for standard insulating version THIW

* refer to CN.12 catalogue page

** refer to CDS catalogue page

*** refer to Supplement October 2013 catalogue page

insert centre distance: 77,5 x 27 mm

hoods with double lever top entry



VITON gasket

covers

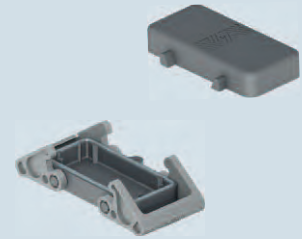

VITON gasket

description	part No.	entry M	part No.
with thermoplastic levers and gasket	TAVW 16 G32	32	
with thermoplastic levers and gasket	TAVW 16 G40	40	
with 4 pegs			TCHC 16
with 2 thermoplastic levers and gasket			THCW 16 G

dimensions in mm

TAVW 16 G32 and TAVW 16 G40

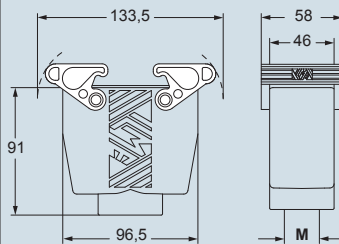

dimensions in mm

TCHC 16

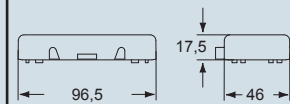

THCW 16 G

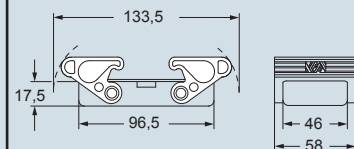

- ambient temperature limits -40 °C/+90 °C

dimensions shown are not binding and may be changed without notice

inserts:		page:
CD	64 poles + ⊕	51 *
CDD	108 poles + ⊕	64 *
CQE	46 poles + ⊕	83 *
CSH	24 poles + ⊕	91 *
CCE	24 poles + ⊕	100 *
CNE, CSE	24 poles + ⊕	101 *
CSS	24 poles + ⊕	121 *
CT, CTE, CTSE *)	24 poles + ⊕	129 and 133 *
CME, CMSE 10+2 (aux)	poles + ⊕	139 *
CMCE	10+2 (aux) poles + ⊕	138 *
CME	16+2 (aux) poles + ⊕	145 *
CMCE	16+2 (aux) poles + ⊕	144 *
CX	4/8 poles + ⊕	155 *
MIXO	6 modules	156-195 *
CDS	42 poles + ⊕	9 **
CQEE	64 poles + ⊕	16 ***

*) only for standard insulating version THIW

* refer to CN.12 catalogue page

** refer to CDS catalogue page

*** refer to Supplement October 2013 catalogue page

insert centre distance: **104 x 27 mm**

hoods with double lever top entry



VITON gasket

covers

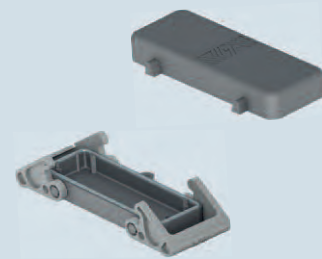

VITON gasket

description	part No.	entry M	part No.
with thermoplastic levers and gasket	TAVW 24 G32	32	
with thermoplastic levers and gasket	TAVW 24 G40	40	
with 4 pegs			TCHC 24
with 2 thermoplastic levers and gasket			THCW 24 G

dimensions in mm

TAVW 24 G32 and TAVW 24 G40

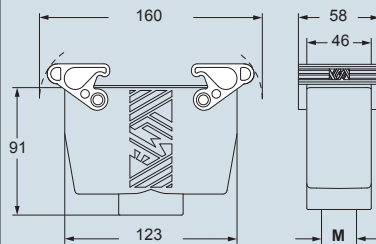

dimensions in mm

TCHC 24

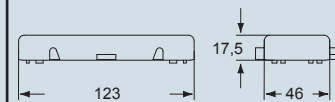

THCW 24 G

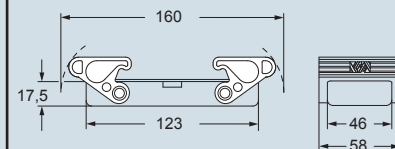

- ambient temperature limits -40 °C/+90 °C

dimensions shown are not binding and may be changed without notice

HYGIENIC

For food and beverage

PASTA



DAIRY



PASTRIES AND BAKERY PRODUCTS



HYGIENIC application fields

food & beverage
applications

CANNED VEGETABLES AND FRUIT JUICE

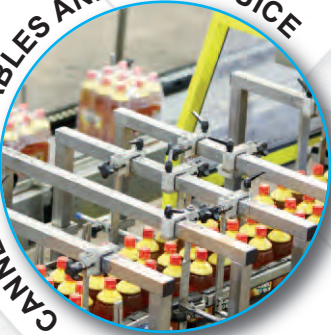

WINE AND SPIRITS



PET FOOD



MEAT AND POULTRY



HYGIENIC

Resistance of materials to detergents/disinfectants used in the food industry

The new **ILME T-Type/H and T-Type/C** enclosure materials have been selected to guarantee compatibility with the principal alkaline or acid detergents and disinfectants used in the food industry. In particular, T-Type/H and T-Type/C

series enclosures have been tested according to protocol **F&E/P3-E n. 40-1 by Ecolab**, leading multinational in the detergent sector, to verify their compatibility with the following cleaning fluids:



- **Acid foaming detergents:** P3-topax 52, P3-topmaxx 520 and P3-topax 56.
- **Alkaline foaming detergents:** P3-topax 19 and Ecofoam Basic.
- **Strong alkaline foaming detergents:** P3-topax 36 and P3-topax 30.

- **Alkaline-chloride foaming detergents-disinfectants:** P3-topax 66, Ecofoam CL and P3-topax M95.
- **Non-foaming peracetic based disinfectants:** P3-oxonia active, P3-topactive OKTO and P3-topactive DES.
- **Neutral disinfectants:** P3-topax 990 and P3-topax 91.

ECOLAB F&E/P3-E n. 40-1 Test Protocol

SEE DECLARATION OF COMPATIBILITY AT PAGES 28-29

- Full immersion of parts in detergent/disinfectant solutions.
- Water hardness of 200ppm CaCO₃
- Concentrations tested 30% higher than those normally recommended

- 28 days total time at 20 °C (equivalent to the contact time that occurs in 6 years of daily cleaning)
- Test solution renewed every 3-4 days for oxidizing products
- Test results evaluation: ISO 40068-1 (esthetic appearance) and mass loss

Cleanability and degrees of protection used in the food industry

T-Type/H and T-Type/C series enclosures have been designed to facilitate cleaning of surfaces that could potentially come into contact with food. For this purpose **T-Type/H and T-Type/C** series enclosures have **IP66 and IP69 degrees of protection as per IEC 60529 Edition 2.2 (2013-08)** to allow jet washing, as typical aspect of the food industry.

The suitability of our products for the **cleanability** requirements stated by Machinery Directive 2006/42/EC for both Splash and Food Area zones (EN 1672-2 and EN ISO 14159) **depends on the specific installation of ILME products on the machine and must be evaluated by the machine manufacturer** (see page 31, Table 1, Applications Zones). In addition to the Hygienic version, aluminium cases are also available with degrees of protection up to IP68 (check applicability).



Declaration of compatibility - By courtesy of ECOLAB s.r.l.



DECLARATION OF COMPATIBILITY

between **ECOLAB** hygiene products
and **ILME** enclosures for multiple connectors

For the completely safe cleaning of your plant



The ideal partner for Industrial Connections for power supply of plug connected devices, connections for auxiliary circuits and automation control:

T-type H and T-type C enclosures



The declaration proves the high resistance of these enclosures to Ecolab products commonly and worldwide used in Food and Beverage Industries.

ILME S.p.a.
Via Marco Antonio Colonna, 9 - 20149 Milano (MI)
www.ilme.com



Supplier of hygiene solutions for Food and Beverage industries

Products



Equipments



Services



Ecolab s.r.l.
Via Paracelso 6 - 20864 Agrate Brianza (MB)
www.it.ecolab.eu

Declaration of compatibility - By courtesy of ECOLAB s.r.l.



Compatible products with T-type/C and T-type/H ILME enclosures

See below for the test procedure

PRODUCT	%	T-TYPE ENCLOSURE	DEFECT QUANTITY	DEFECT QUALITY	COLOR VARIATION
P3-topax 52	6	C and H	0	0	0
P3-topax 19	6	C and H	0	0	0
P3-topax 36	6	C and H	0	0	0
P3-topax 91	6	C and H	0	0	0
P3-topax 990	6	C and H	0	0	0
P3-oxonia active	1	C and H	0	0	0
P3-topactive okto	3	C and H	0	0	0
P3-topax 66	6	C and H	0	0	0

DEFECT QUANTITY: 0 means - No detectable defect
 DEFECT QUALITY: 0 means - Up to 10x magnification no detectable defect
 COLOR VARIATION: 0 means - Unchanged, no discoloration

Test procedure

- Test performed by Ecolab Technical Application Service
- Ecolab reference method 40.1 – ISO 4068-1 for the evaluation
- Full immersion of parts in detergent/disinfectant solutions
- Water hardness of 200ppm CaCO₃
- 8 days total time at 20°C (equivalent to the contact time that occurs in 6 years of daily cleaning)
- Concentrations tested 30% higher than those normally recommended
- Test solution renewed every 3-4 days for oxidizing products (P3-oxonia active, P3-topactive OKTO, P3-topax 66)

Final statement

- The Ecolab Technical Application Service Italy certifies that the ILME enclosures for multipole connectors T-type/C and T-type/H are perfectly compatible with the above listed Ecolab detergents and disinfectants used in a concentration 30% higher than those normally recommended.

January 2015

HYGIENIC

Requirements on materials in contact or that may come into contact with food products

Materials have been selected to satisfy the requirements of **EHEDG Guideline n° 32** “Materials of construction for food equipment in contact with food” and point 2.1.1, letter a) in Annex I of the **Machinery Directive 2006/42/EC**. Paragraph 91 of the **Guide to the application of Machinery Directive 2006/42/EC** specifies that the reference at Annex I, point 2.1.1, letter a) of the directive must be considered as a reference to **EC regulation n. 1935/2004** and **directive 2002/72/EC**.

EU commission regulation n. 10/2011 dated 14 January 2011, concerning plastic material and objects designed for contact with food products, is a specific measure as provided for by article 5, paragraph 1 of the above-mentioned **EC regulation n. 1935/2004**.

It defines specific regulations for plastic materials and objects in order to guarantee their use in safe conditions and supersedes commission **directive 2002/72/EC** dated 6 August 2002 on plastic materials and objects designed for

contact with food products. Art. 2, section 2 of the above-mentioned **EU regulation n. 10/2011** specifies that **rubber and silicone** do not fall within the field of application of the regulation.

EU regulation n. 10/2011 provides for the use of materials in positive lists of technological monomers, additives and adjuvants and the passing of global and specific migration tests in food simulants.

ILME **T-Type/C** series enclosure materials have been selected according to **EU n. 10/2011** regulation requirements and each component has been tested according to **EU regulation n. 10/2011** and **EC regulation n. 1935/2004**.

Furthermore, T-Type/C series gasket materials have been formulated according to **FDA Guideline 21 CFR §177.2600** and T-Type enclosures and levers materials complying with **FDA, 21 CFR, §177.1520** (a)(3)(i)(c)(1), (b) and (c)3.1a.





HYGIENIC

Risk Assessment and Critical Control Points in the food industry

Companies that work in the food sector must implement **HACCP**, i.e. Hazard Analysis and Critical Control Points system (**EC Regulation 852/2004** on food product hygiene in force since 01/01/2006) and can voluntarily apply for various certificates (ISO 22000, BRC, ISF, etc.).

All those involved in primary food production (harvesting, milking, breeding), its preparation, transformation, manufacturing, packaging, storage, transport, distribution, handling, sales or supply, including consumer catering, are required to implement an HACCP system, i.e. a series of procedures aimed at preventing food contamination hazards. HACCP is based on monitoring food processing points where

biological, chemical or physical contamination hazards may arise. In 2006, HACCP was made mandatory for companies that deal with the food for animals (production of raw materials, mixtures and additives).

A company required to implement HACCP can initially be divided into three zones from the point of view of food risk. The choice of the zone in which the wiring and connectors are installed depends on the risk assessment the manufacturer must conduct as per **Machinery Directive 2006/42/EC** which, in chapter 2.1, sets out the additional requirements for the food industry.

Table 1. According to EN 1672-2:2009 - Food processing machinery - Basic concepts - Part 2: Hygiene requirements

Application Zones	Zone Requirements	Usable Products
<p>No Food Area: Zone where there is <u>no contact risk</u> with food.</p>	<p><u>No additional requirement</u> for the food industry.</p>	<p>Enclosures series T-Type, T-Type/W, C-Type, BIG, IP68, C7 IP67, W-Type, EMC, COB, ...</p>
<p>Splash Area: Zone where <u>components may come into contact with food</u> but <u>there is no risk that the food</u> that came into contact with the components in this area <u>returns to the production cycle</u>.</p>	<p>In this zone, <u>components</u> also come into contact with cleaning agents used in the food industry and <u>must therefore be cleanable and resistant to the washing process</u> (see "Resistance of materials to detergents/disinfectants used in the food industry" and "Cleanability and degrees of protection used in the food industry", see page 27).</p>	<p>New <u>Hygienic</u> version enclosures series <u>T-Type/H</u> and <u>T-Type/C</u>.</p>
<p>Food Area: Zone where <u>components may come into contact with food</u>, with the risk that <u>the food</u> that came into contact with the components in this area <u>returns to the production cycle</u>.</p>	<p>In this zone, in addition to complying with the cleanability and washing requirements, the <u>components</u> are also subject to a series of more <u>stringent requirements</u> aimed at making negligible the <u>risk of food contamination</u> in the process (see paragraph "Requirements on materials in contact or that can come into contact with food products", see page 30).</p>	<p>For more information about T-Type/C in special version, please contact our Offices.</p>

Food & Beverage Hygiene Requirements

Low Temperatures
> Splash Area

Application Zones



Splash Area

Zone Requirements

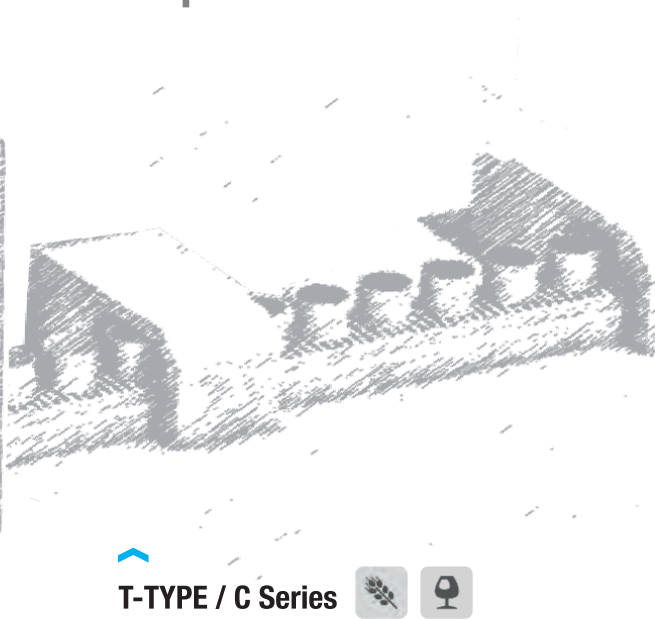
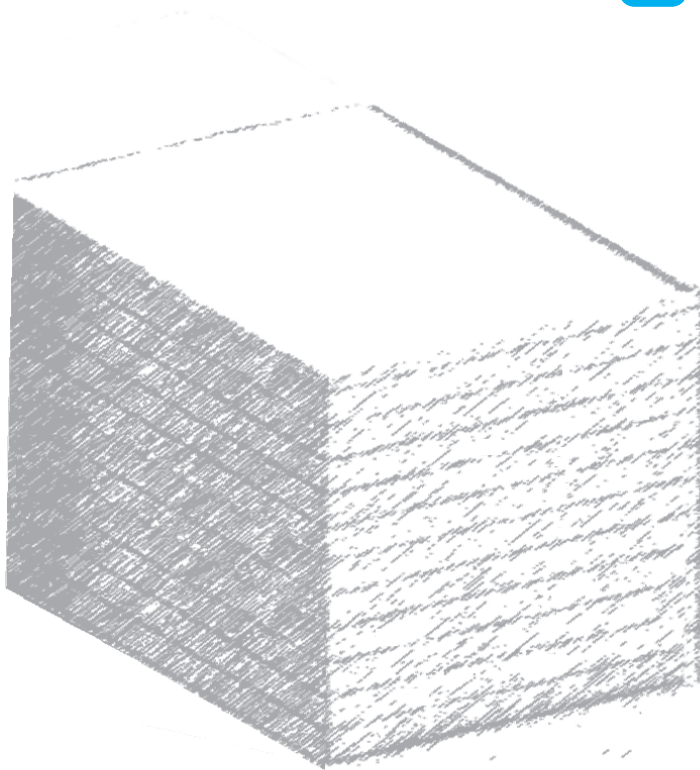

T-TYPE / C Series



HYGIENIC / C



Range of temperature:
-50 °C / +70 °C

Usable Products

Production lines
› **Splash Area**

› **No Food Area**



Splash Area

No Food Area

Zone where components may come into contact with food but there is no risk that the food that came into contact with the components in this area returns to the production cycle.

Zone where there is no contact risk with food.

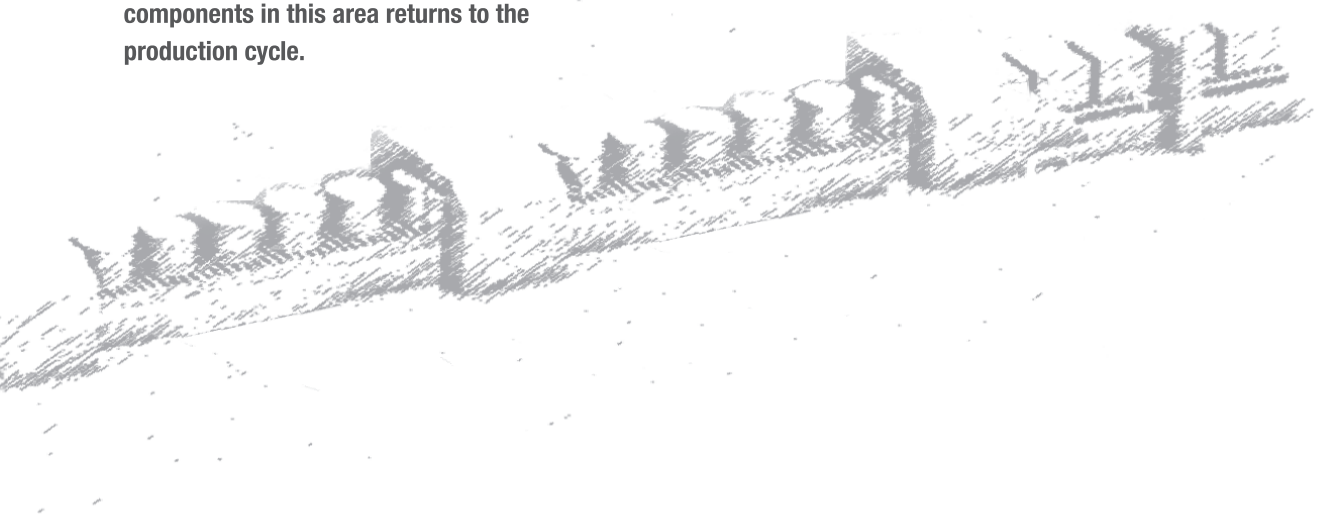

^ **T-TYPE / H Series**  

^ **STANDARD Series**

HYGIENIC / H



Insulating enclosures with resistance of materials to detergents / disinfectants

T-TYPE Std. & W



Insulating enclosures, up to 200A inserts



www.ilme.com

HYGIENIC

T-TYPE/H & T-TYPE/C

The evolution of T-Type insulating enclosures meets food and beverage requirements

HYGIENIC

food & beverage applications

IP66
IP69

ECOLAB
Everywhere It Matters.



The new Hygienic multi-pole connector enclosures version (**series T-Type/H and T-Type/C**) has been designed for installation on food industry machines and systems.

For this purpose, the following improvements to the T-Type series have been made in order to satisfy the requirements laid down by chapter 2.1 of **Machinery Directive 2006/42/EC** for the machines on which they are installed:

- material cleanability and resistance to the cleaning and sanitising agents normally used in the food industry;
- materials in terms of the requirements for accidental contact with food products.

The T-Type/H and T-Type/C series enclosures fit different sealing gaskets. For T-Type/H series enclosures, the sealing gasket is in HNBR rubber, a material with excellent resistance to both acidic and alkaline detergents as well as any animal and vegetable fats it could come into contact with in food industry applications. For T-Type/C series enclosures, the sealing gasket is made by silicone rubber, a material with good resistance to acidic and alkaline

detergents as well as animal and vegetable fats. It is also characterised by its improved resistance to low temperatures (series suitable for uses as low as -50 °C), conditions that can arise in food industries that use the cold chain.

A dedicated variant of this new Hygienic version may be used where a high risk of accidental contact with food is occurring during production (see page 33, Table 1, Application Zones, Food Area). For more information about this possible special version, please contact our Offices.

In accordance with the requirements set forth in **EHEDG Guideline n. 32** "Materials of construction for food equipment in contact with food" (EHEDG = European Hygienic Engineering & Design Group), the closing levers and sealing gaskets are coloured blue to easily identify any accidental contaminations in food products and to facilitate the visual identification of their complete cleanliness.

HYGIENIC

T-TYPE/H & T-TYPE/C

T-TYPE / H

PRODUCTION LINES APPLICATIONS



DATA SHEETS AT PAGES 38-45

- › Enclosures in **thermoplastic material, dark grey RAL 7012 colour**, with high thicknesses providing structural solidity and durability.
- › Sealing gaskets made by **HNBR rubber formulated in accordance with FDA Guideline 21 CFR §177.2600**.
- › Levers in **thermoplastic material, blue RAL 5015 colour**.
- › **M25, M32 and M40** threaded cable entries.
- › **IP66 and IP69** degree of protection according to **EN 60529**.
- › Each enclosure carries its own part number, thread/size and conformity **markings**.
- › Ambient temperature range: **-40 °C / +70 °C**.

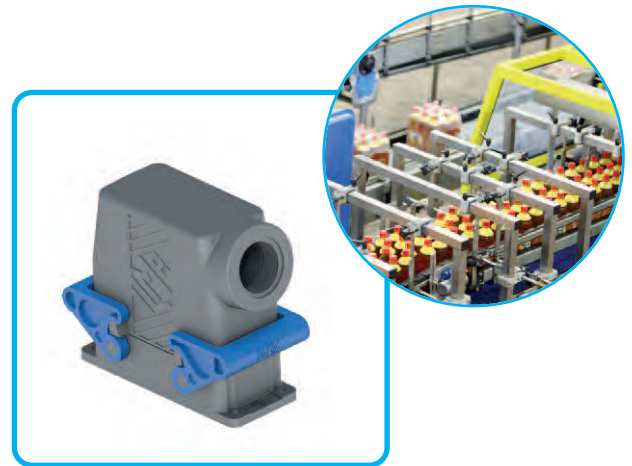

T-TYPE / C

LOW TEMPERATURE APPLICATIONS



DATA SHEETS AT PAGES 46-53

- › The **Hygienic T-Type/C Series enclosures** have been **specifically designed** for food and beverage ambient temperature as low as **-50 °C (range: -50 °C / +70 °C)**.
- › Enclosures in **thermoplastic material, dark grey RAL 7012 colour**, with high thicknesses providing structural solidity and durability.
- › This version differs from the Hygienic T-Type/H one for the **sealing gaskets** made by in accordance with **FDA Guideline 21 CFR §177.2600**.
- › ILME **T-Type/C** series enclosure materials have been selected according to **EU n. 10/2011** regulation requirements and each component has been tested according to **EU regulation n. 10/2011** and **EC regulation n. 1935/2004**.

NOTE: As the characterizing elements of the Hygienic Series are the different sealing gasket material and the different locking lever, hoods and covers without sealing gaskets and locking levers are the same of series T-Type Standard.

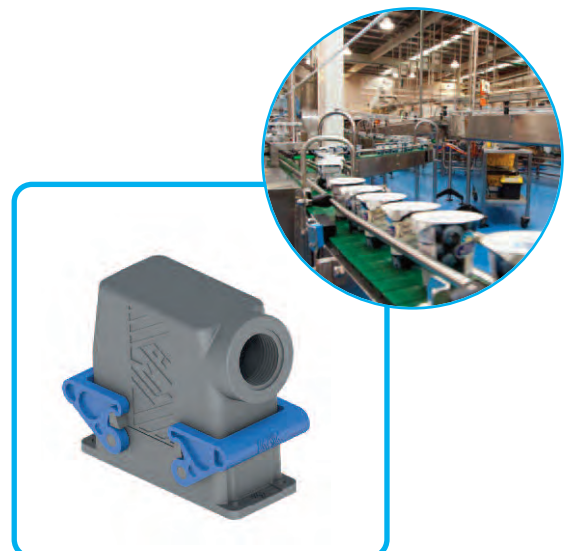

HYGIENIC

T-TYPE/H & T-TYPE/C

FOCUS ON:

1 Construction

By using the BC-MUL[®] moulding technique together with the use of MIL.BOX[®] material, **these enclosures are structurally solid and mechanically robust**, due to their increased thickness. They are particularly resistant to the main pollutants present in industrial environments. The lever enclosure pegs are built into the enclosures. The methods for fastening the connectors to the enclosures are made by M3 threaded metal inserts. With reference to metal construction, which to comply with electrical installation safety norms, must be earthed via a metal connection to the protective earth terminal of the connector inserts inside the enclosure, **the new series of enclosures offers a solution for total insulation constructions** ☐ (equivalent to class II) where necessary.

The thermoplastic material used is RAL 7012 dark grey colour and has passed **glow wire** testing in accordance with the IEC (EN) 60695-2-11 at **650 °C** in compliance with intended uses.

2 Gaskets

Gaskets have been produced in **HNBR rubber or SILICONE rubber** and have been incorporated in the base flange on bulkhead mounting housings for easier installation.

3 Levers

The locking levers have been produced in **self-extinguishing thermoplastic material**, blue RAL 5015 colour.

4 Dimensions

The internal dimensions allow mounting of all connector inserts in their relevant sizes. The external dimensions of the bulkhead mounting housings are similar to those of the corresponding metallic enclosures; hole fixing centres are unchanged. Hoods offer an inner cabling space similar to that of the “high” construction models of the corresponding metal enclosures. Other characteristics are in compliance with the applicable safety standard for electrical connectors, **IEC/EN 61984**.

5 Cable entries

The housing and hood cable entries are available with metric thread, respectively:

- **M25 or M32** for smaller sizes “44.27” and “57.27”.
- **M32 or M40** for larger sizes “77.27” and “104.27”.

The surface mounting, high construction housings are supplied with an open threaded entry and diametrically opposite a closed threaded entry which can be opened by the user if required (with suitable tool).

The recent standard **IEC/EN 61076-7-100** regarding metric cable entries for multipole electrical connectors for heavy duty uses, which standardises some main dimensions for entries and their related accessories (gaskets, pressure nuts), have been carefully considered in the product design.

6 Markings

Each enclosure carries its own part number and conformity markings.



HYGIENIC

Featuring an original design, T-TYPE/H & T-TYPE/C construction types available are:

surface mounting housings
with double entry of which
one closed but threaded



hoods
with levers



bulkhead mounting housings



hoods
with side entry



hoods
with top entry



covers
with pegs (for housings)
with levers (for hoods)



single lever, side and top entry,
for size "44.27"



single lever, side and top entry,
for size "44.27"



double lever, side and top entry,
for other sizes "57.27, 77.27, 104.27"



double lever, side and top entry,
for other sizes "57.27, 77.27, 104.27"

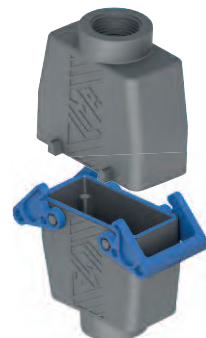

inserts:	page:
CDD 24 poles + ⊕	59 *
CQE 10 poles + ⊕	80 *
CSH 6 poles + ⊕	88 *
CCE 6 poles + ⊕	94 *
CNE, CSE 6 poles + ⊕	95 *
CSS 6 poles + ⊕	118 *
CT, CTE, CTSE *) .. 6 poles + ⊕	126 and 130 *
MIXO 2 modules	156-195 *
CDS 9 poles + ⊕	6 **

*) only for standard insulating version THIH

* refer to CN.12 catalogue page

** refer to CDS catalogue page

insert centre distance: 44 x 27 mm

housings with single lever



HNBR gasket

hoods with 2 pegs



description	part No.	entry M
bulkhead mounting housing with thermoplastic lever	THIH 06 L	
surface mounting housing with thermoplastic lever	TAPH 06 L25	25
surface mounting housing with thermoplastic lever	TAPH 06 L32	32
with pegs, side entry		
with pegs, side entry		

description	part No.	entry M
with pegs, side entry	TMAO 06 L25	25
with pegs, side entry	TMAO 06 L32	32
with pegs, side entry	TMAV 06 L25	25
with pegs, side entry	TMAV 06 L32	32

description	part No.	entry M
with pegs, side entry	TMAO 06 L25	25
with pegs, side entry	TMAO 06 L32	32
with pegs, side entry	TMAV 06 L25	25
with pegs, side entry	TMAV 06 L32	32

panel cut-out for bulkhead mounting housing in mm

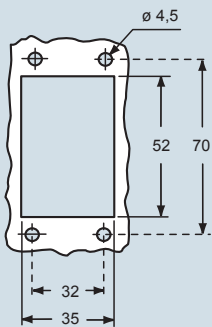

dimensions in mm

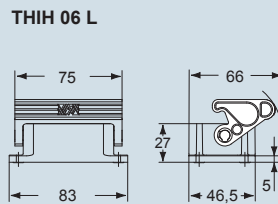

dimensions in mm

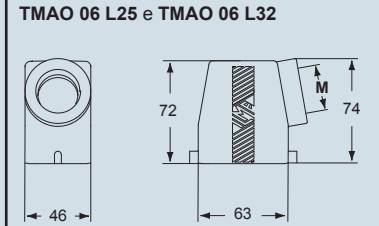

TAPH 06 L25 and TAPH 06 L32

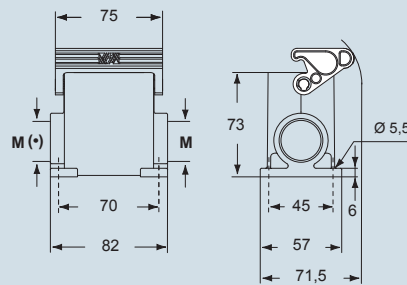

TMAV 06 L25 and TMAV 06 L32

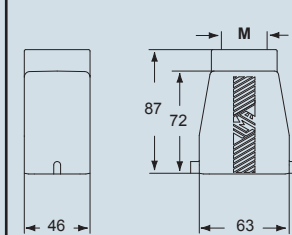

(+) The surface mounting, high construction housings are supplied with an open threaded entry (+) and diametrically opposite a closed threaded entry which can be opened by the user if required (with suitable tool).



- ambient temperature limits -40 °C / +70 °C

dimensions shown are not binding and may be changed without notice

inserts:	page:	
CDD 24 poles + ⊕	59 *	
CQE 10 poles + ⊕	80 *	
CSH 6 poles + ⊕	88 *	
CCE 6 poles + ⊕	94 *	
CNE, CSE 6 poles + ⊕	95 *	
CSS 6 poles + ⊕	118 *	
CT, CTE, CTSE *) .. 6 poles + ⊕	126 and 130 *	
MIXO 2 modules	156-195 *	
CDS 9 poles + ⊕	6 **	

*) only for standard insulating version THIH

* refer to CN.12 catalogue page

** refer to CDS catalogue page

insert centre distance: 44 x 27 mm

hoods with single lever top entry



HNBR gasket

covers



HNBR gasket

description	part No.		entry M	
	with thermoplastic lever and gasket	TAVH 06 LG25	25	
with thermoplastic lever and gasket	TAVH 06 LG32	32		
with pegs				TCHC 06 L
with thermoplastic lever and gasket				THCH 06 LG

dimensions in mm

TAVH 06 LG25 and TAVH 06 LG32

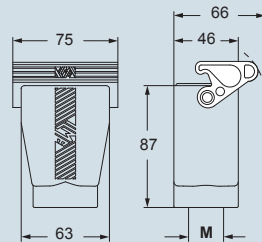

dimensions in mm

TCHC 06 L

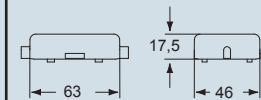

THCH 06 LG

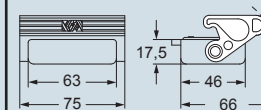

- ambient temperature limits -40 °C / +70 °C

dimensions shown are not binding and may be changed without notice

inserts:		page:
CDD	42 poles + ⊕	61 *
CQE	18 poles + ⊕	81 *
CSH	10 poles + ⊕	89 *
CCE	10 poles + ⊕	96 *
CNE, CSE	10 poles + ⊕	97 *
CSS	10 poles + ⊕	119 *
CT, CTE, CTSE *)	10 poles + ⊕	127 and 131 *
CMSE	3+2 (aux) poles + ⊕	135 *
CMCE	3+2 (aux) poles + ⊕	134 *
CME	3+2 (aux) poles + ⊕	135 *
CX	8/24 poles + ⊕	151 *
MIXO	3 modules	156-195 *
CDS	18 poles + ⊕	7 **

*) only for standard insulating version THIH

* refer to CN.12 catalogue page

** refer to CDS catalogue page

insert centre distance: 57 x 27 mm

housings with double lever



HNBR gasket

hoods with 4 pegs



description	part No.	entry M
bulkhead mounting housing with thermoplastic levers	THIH 10	
surface mounting housing with thermoplastic levers	TAPH 10.25	25
surface mounting housing with thermoplastic levers	TAPH 10.32	32
with pegs, side entry		
with pegs, side entry		
with pegs, top entry		
with pegs, top entry		

part No.	entry M

part No.	entry M

panel cut-out for bulkhead mounting housing in mm

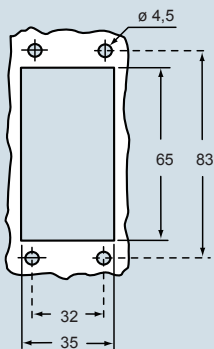

dimensions in mm

THIH 10

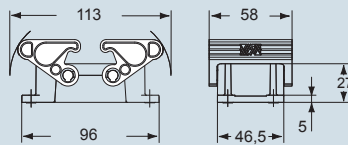

TAPH 10.25 and TAPH 10.32

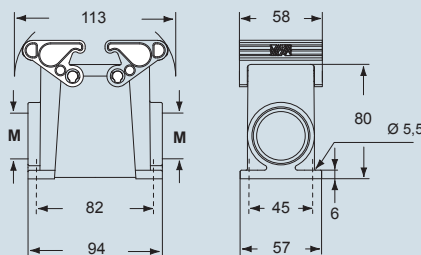

dimensions in mm

TMAO 10.25 and TMAO 10.32

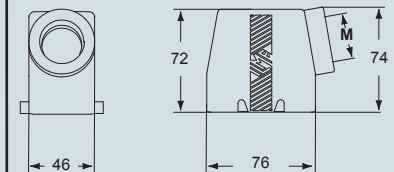

TMAV 10.25 and TMAV 10.32

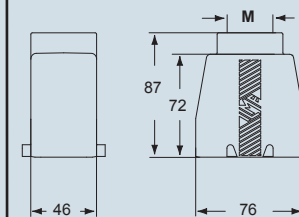

The surface mounting, high construction housings are supplied with an open threaded entry and diametrically opposite a closed threaded entry which can be opened by the user if required (with suitable tool).



- ambient temperature limits -40 °C / +70 °C

dimensions shown are not binding and may be changed without notice

inserts:		page:
CDD	42 poles + ⊕	61 *
CQE	18 poles + ⊕	81 *
CSH	10 poles + ⊕	89 *
CCE	10 poles + ⊕	96 *
CNE, CSE	10 poles + ⊕	97 *
CSS	10 poles + ⊕	119 *
CT, CTE, CTSE *)	10 poles + ⊕	127 and 131 *
CMSE	3+2 (aux) poles + ⊕	135 *
CMCE	3+2 (aux) poles + ⊕	134 *
CME	3+2 (aux) poles + ⊕	135 *
CX	8/24 poles + ⊕	151 *
MIXO	3 modules	156-195 *
CDS	18 poles + ⊕	7 **

*) only for standard insulating version THIH

* refer to CN.12 catalogue page

** refer to CDS catalogue page

insert centre distance: 57 x 27 mm

hoods with double lever top entry



HNBR gasket

covers



HNBR gasket

description	part No.	entry M	part No.
with thermoplastic levers and gasket	TAVH 10 G25	25	
with thermoplastic levers and gasket	TAVH 10 G32	32	
with 4 pegs			TCHC 10
with 2 thermoplastic levers and gasket			THCH 10 G

dimensions in mm

TAVH 10 G25 and TAVH 10 G32

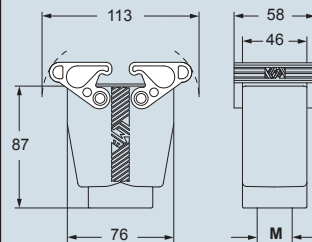

dimensions in mm

TCHC 10

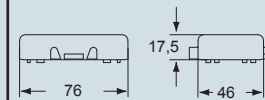

THCH 10 G

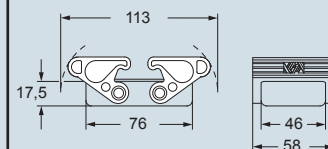

- ambient temperature limits -40 °C / +70 °C

dimensions shown are not binding and may be changed without notice

inserts:		page:
CD	40 poles + ⊕	49 *
CDD	72 poles + ⊕	62 *
CQE	32 poles + ⊕	82 *
CSH	16 poles + ⊕	90 *
CCE	16 poles + ⊕	98 *
CNE, CSE	16 poles + ⊕	99 *
CSS	16 poles + ⊕	120 *
CT, CTE, CTSE *) ..	16 poles + ⊕ 128 and 132 *	132 *
CME, CMSE 6+2 (aux)	poles + ⊕	137 *
CMCE	6+2 (aux) poles + ⊕	136 *
CP	6 poles + ⊕	149 *
CX	6/36 and 12/2 poles + ⊕	152-153 *
CX	4/0 and 4/2 poles + ⊕	154 *
MIXO	4 modules	156-195 *
CDS	27 poles + ⊕	8 **
CQEE	40 poles + ⊕	15 ***

*) only for standard insulating version THIH

* refer to CN.12 catalogue page

** refer to CDS catalogue page

*** refer to Supplement October 2013 catalogue page

insert centre distance: 77,5 x 27 mm

housings with double lever



HNBR gasket

hoods with 4 pegs



description	part No.	entry M
bulkhead mounting housing with thermoplastic levers	THIH 16	
surface mounting housing with thermoplastic levers	TAPH 16.32	32
surface mounting housing with thermoplastic levers	TAPH 16.40	40
with pegs, side entry		
with pegs, side entry		
with pegs, top entry		
with pegs, top entry		

part No.	entry M

part No.	entry M
TMAO 16.32	32
TMAO 16.40	40
TMAV 16.32	32
TMAV 16.40	40

panel cut-out for bulkhead mounting housing in mm

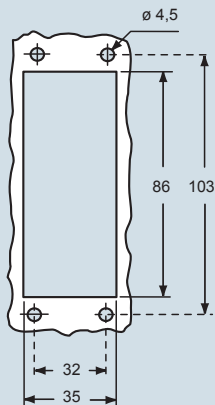

dimensions in mm

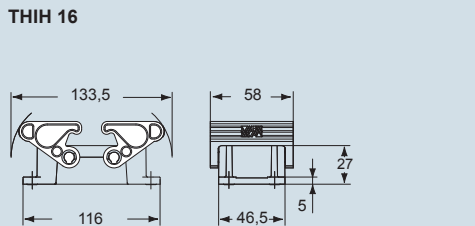

dimensions in mm

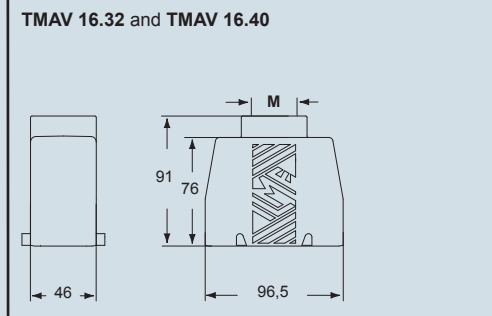
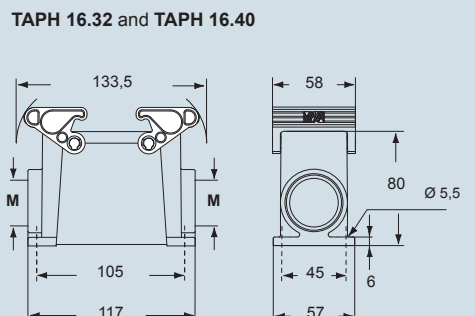
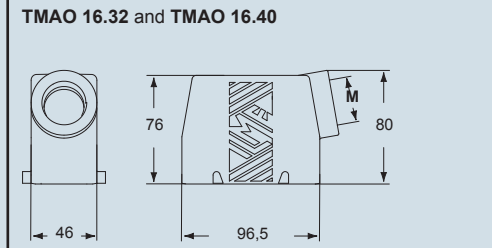

The surface mounting, high construction housings are supplied with an open threaded entry and diametrically opposite a closed threaded entry which can be opened by the user if required (with suitable tool).



- ambient temperature limits -40 °C / +70 °C

dimensions shown are not binding and may be changed without notice

inserts:		page:
CD	40 poles + ⊕	49 *
CDD	72 poles + ⊕	62 *
CQE	32 poles + ⊕	82 *
CSH	16 poles + ⊕	90 *
CCE	16 poles + ⊕	98 *
CNE, CSE	16 poles + ⊕	99 *
CSS	16 poles + ⊕	120 *
CT, CTE, CTSE *) ..	16 poles + ⊕ 128 and 132 *	
CME, CMSE 6+2 (aux)	poles + ⊕	137 *
CMCE	6+2 (aux) poles + ⊕	136 *
CP	6 poles + ⊕	149 *
CX	6/36 and 12/2 poles + ⊕	152-153 *
CX	4/0 and 4/2 poles + ⊕	154 *
MIXO	4 modules	156-195 *
CDS	27 poles + ⊕	8 **
CQEE	40 poles + ⊕	15 ***

*) only for standard insulating version THIH
 * refer to CN.12 catalogue page
 ** refer to CDS catalogue page
 *** refer to Supplement October 2013 catalogue page
 insert centre distance: 77,5 x 27 mm

hoods with double lever top entry



HNBR gasket

covers



HNBR gasket

description	part No.	entry M	part No.
with thermoplastic levers and gasket	TAVH 16 G32	32	TCHC 16
with thermoplastic levers and gasket	TAVH 16 G40	40	THCH 16 G
with 4 pegs			
with 2 thermoplastic levers and gasket			

dimensions in mm

TAVH 16 G32 and TAVH 16 G40

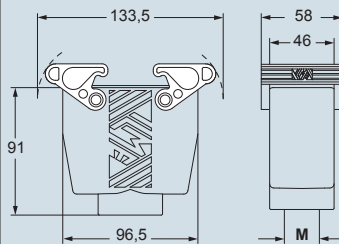

dimensions in mm

TCHC 16

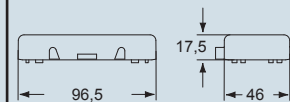

THCH 16 G

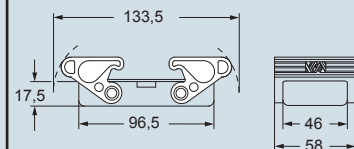

- ambient temperature limits -40 °C / +70 °C

dimensions shown are not binding and may be changed without notice

inserts:	page:
CD 64 poles + ⊕	51 *
CDD 108 poles + ⊕	64 *
CQE 46 poles + ⊕	83 *
CSH 24 poles + ⊕	91 *
CCE 24 poles + ⊕	100 *
CNE, CSE 24 poles + ⊕	101 *
CSS 24 poles + ⊕	121 *
CT, CTE, CTSE *) 24 poles + ⊕	129 and 133 *
CME, CMSE 10+2 (aux) poles + ⊕	139 *
CMCE 10+2 (aux) poles + ⊕	138 *
CME 16+2 (aux) poles + ⊕	145 *
CMCE 16+2 (aux) poles + ⊕	144 *
CX 4/8 poles + ⊕	155 *
MIXO 6 modules	156-195 *
CDS 42 poles + ⊕	9 **
CQEE 64 poles + ⊕	16 ***

*) only for standard insulating version THIH
 * refer to CN.12 catalogue page
 ** refer to CDS catalogue page
 *** refer to Supplement October 2013 catalogue page
 insert centre distance: 104 x 27 mm

housings with double lever



HNBR gasket

hoods with 4 pegs



description	part No.	entry M
bulkhead mounting housing with thermoplastic levers	THIH 24	
surface mounting housing with thermoplastic levers	TAPH 24.32	32
surface mounting housing with thermoplastic levers	TAPH 24.40	40
with pegs, side entry		
with pegs, side entry		
with pegs, top entry		
with pegs, top entry		

part No.	entry M

part No.	entry M

panel cut-out for bulkhead mounting housing in mm

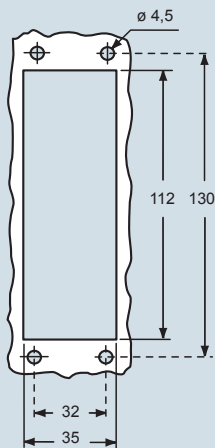

dimensions in mm

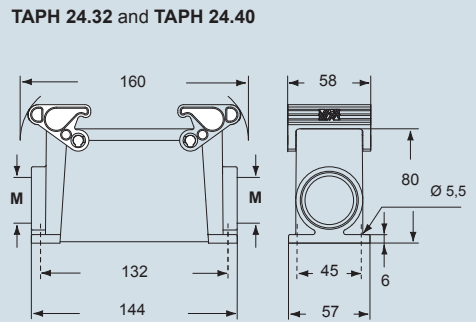
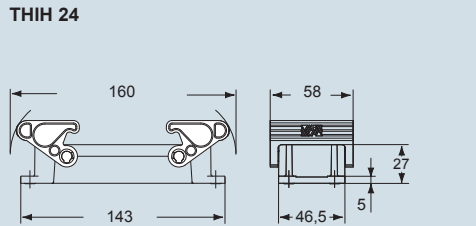

dimensions in mm

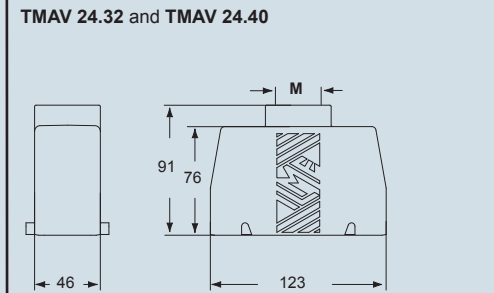
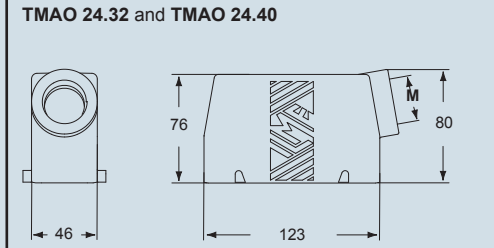

The surface mounting, high construction housings are supplied with an open threaded entry and diametrically opposite a closed threaded entry which can be opened by the user if required (with suitable tool).



- ambient temperature limits -40 °C / +70 °C

dimensions shown are not binding and may be changed without notice

inserts:		page:
CD	64 poles + ⊕	51 *
CDD	108 poles + ⊕	64 *
CQE	46 poles + ⊕	83 *
CSH	24 poles + ⊕	91 *
CCE	24 poles + ⊕	100 *
CNE, CSE	24 poles + ⊕	101 *
CSS	24 poles + ⊕	121 *
CT, CTE, CTSE *)	24 poles + ⊕	129 and 133 *
CME, CMSE 10+2 (aux)	poles + ⊕	139 *
CMCE	10+2 (aux) poles + ⊕	138 *
CME	16+2 (aux) poles + ⊕	145 *
CMCE	16+2 (aux) poles + ⊕	144 *
CX	4/8 poles + ⊕	155 *
MIXO	6 modules	156-195 *
CDS	42 poles + ⊕	9 **
CQEE	64 poles + ⊕	16 ***

*) only for standard insulating version THIH

* refer to CN.12 catalogue page

** refer to CDS catalogue page

*** refer to Supplement October 2013 catalogue page

insert centre distance: 104 x 27 mm

hoods with double lever top entry



HNBR gasket

covers

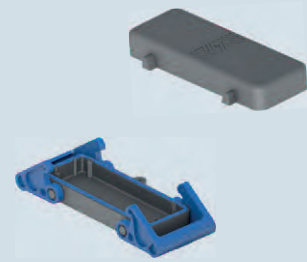

HNBR gasket

description	part No.	entry M	part No.
with thermoplastic levers and gasket	TAVH 24 G32	32	TCHC 24
with thermoplastic levers and gasket	TAVH 24 G40	40	THCH 24 G
with 4 pegs			
with 2 thermoplastic levers and gasket			

dimensions in mm

TAVH 24 G32 and TAVH 24 G40

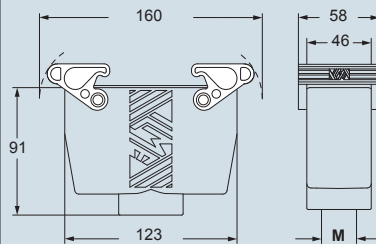

dimensions in mm

TCHC 24

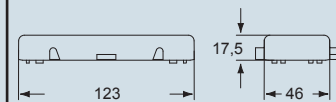

THCH 24 G

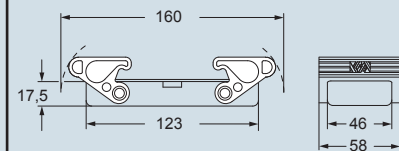

- ambient temperature limits -40 °C / +70 °C

dimensions shown are not binding and may be changed without notice

inserts:	page:
CDD 24 poles + ⊕	59 *
CQE 10 poles + ⊕	80 *
CSH 6 poles + ⊕	88 *
CCE 6 poles + ⊕	94 *
CNE, CSE 6 poles + ⊕	95 *
CSS 6 poles + ⊕	118 *
CT, CTE, CTSE *) .. 6 poles + ⊕	126 and 130 *
MIXO 2 modules	156-195 *
CDS 9 poles + ⊕	6 **

*) only for standard insulating version THIC

* refer to CN.12 catalogue page

** refer to CDS catalogue page

insert centre distance: 44 x 27 mm

housings with single lever



SILICONE gasket

hoods with 2 pegs



description	part No.	entry M
bulkhead mounting housing with thermoplastic lever	THIC 06 L	
surface mounting housing with thermoplastic lever	TAPC 06 L25	25
surface mounting housing with thermoplastic lever	TAPC 06 L32	32
with pegs, side entry		
with pegs, side entry		
con piolini, uscita verticale		
con piolini, uscita verticale		

description	part No.	entry M
bulkhead mounting housing with thermoplastic lever	THIC 06 L	
surface mounting housing with thermoplastic lever	TAPC 06 L25	25
surface mounting housing with thermoplastic lever	TAPC 06 L32	32
with pegs, side entry		
with pegs, side entry		
con piolini, uscita verticale		
con piolini, uscita verticale		

description	part No.	entry M
bulkhead mounting housing with thermoplastic lever	THIC 06 L	
surface mounting housing with thermoplastic lever	TAPC 06 L25	25
surface mounting housing with thermoplastic lever	TAPC 06 L32	32
with pegs, side entry		
with pegs, side entry		
con piolini, uscita verticale		
con piolini, uscita verticale		

panel cut-out for bulkhead mounting housing in mm

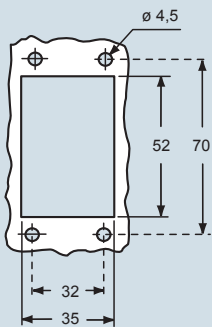

dimensions in mm

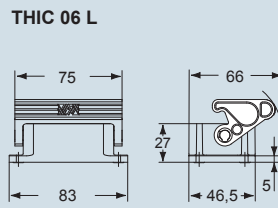

dimensions in mm

TMAO 06 L25 and TMAO 06 L32

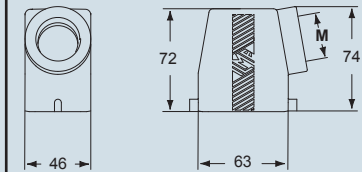

TAPC 06 L25 and TAPC 06 L32

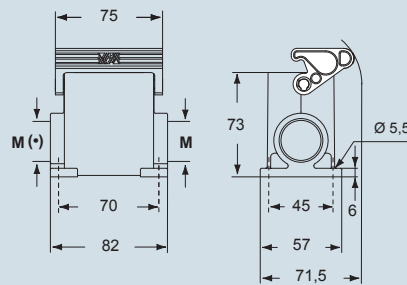

TMAV 06 L25 and TMAV 06 L32

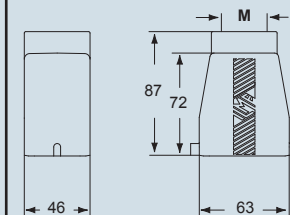

(+) The surface mounting, high construction housings are supplied with an open threaded entry (+) and diametrically opposite a closed threaded entry which can be opened by the user if required (with suitable tool).



- ambient temperature limits -50 °C/+70 °C

dimensions shown are not binding and may be changed without notice

inserts:	page:
CDD 24 poles + ⊕	59 *
CQE 10 poles + ⊕	80 *
CSH 6 poles + ⊕	88 *
CCE 6 poles + ⊕	94 *
CNE, CSE 6 poles + ⊕	95 *
CSS 6 poles + ⊕	118 *
CT, CTE, CTSE *) .. 6 poles + ⊕	126 and 130 *
MIXO 2 modules	156-195 *
CDS 9 poles + ⊕	6 **

*) only for standard insulating version THIC

* refer to CN.12 catalogue page
 ** refer to CDS catalogue page

insert centre distance: **44 x 27 mm**

hoods with single lever top entry



SILICONE gasket

covers



SILICONE gasket

description	part No.	entry M	part No.
with thermoplastic lever and gasket	TAVC 06 LG25	25	
with thermoplastic lever and gasket	TAVC 06 LG32	32	
with pegs			TCHC 06 L
with thermoplastic lever and gasket			THCC 06 LG

dimensions in mm

TAVC 06 LG25 and TAVC 06 LG32

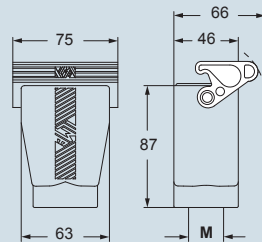

dimensions in mm

TCHC 06 L

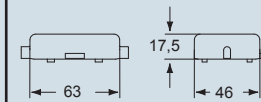

THCC 06 LG

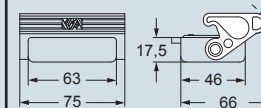

- ambient temperature limits -50 °C/+70 °C

dimensions shown are not binding and may be changed without notice

inserts:	page:
CDD 42 poles + ⊕	61 *
CQE 18 poles + ⊕	81 *
CSH 10 poles + ⊕	89 *
CCE 10 poles + ⊕	96 *
CNE, CSE 10 poles + ⊕	97 *
CSS 10 poles + ⊕	119 *
CT, CTE, CTSE *) 10 poles + ⊕	127 and 131 *
CMSE 3+2 (aux) poles + ⊕	135 *
CMCE 3+2 (aux) poles + ⊕	134 *
CME 3+2 (aux) poles + ⊕	135 *
CX 8/24 poles + ⊕	151 *
MIXO 3 modules	156-195 *
CDS 18 poles + ⊕	7 **

*) only for standard insulating version THIC

* refer to CN.12 catalogue page

** refer to CDS catalogue page

insert centre distance: 57 x 27 mm

housings with double lever



SILICONE gasket

hoods with 4 pegs



description	part No.	entry M	part No.	entry M
bulkhead mounting housing with thermoplastic levers	THIC 10			
surface mounting housing with thermoplastic levers	TAPC 10.25	25		
surface mounting housing with thermoplastic levers	TAPC 10.32	32		
with pegs, side entry			TMAO 10.25	25
with pegs, side entry			TMAO 10.32	32
with pegs, top entry			TMAV 10.25	25
with pegs, top entry			TMAV 10.32	32

panel cut-out for bulkhead mounting housing in mm

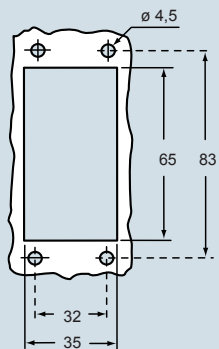

dimensions in mm

THIC 10

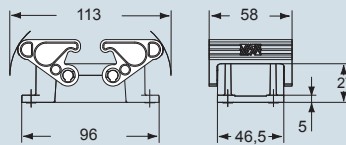

TAPC 10.25 and TAPC 10.32

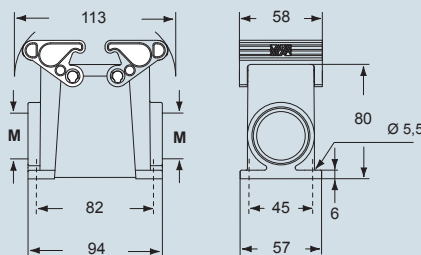

dimensions in mm

TMAO 10.25 and TMAO 10.32

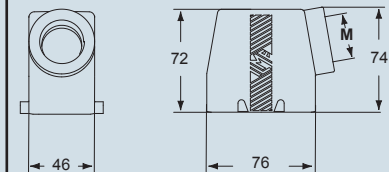

TMAV 10.25 and TMAV 10.32

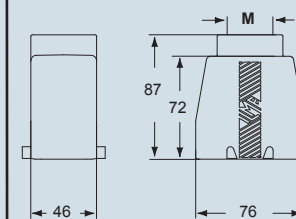

The surface mounting, high construction housings are supplied with an open threaded entry and diametrically opposite a closed threaded entry which can be opened by the user if required (with suitable tool).



- ambient temperature limits -50 °C/+70 °C

dimensions shown are not binding and may be changed without notice

inserts:		page:
CDD	42 poles + ⊕	61 *
CQE	18 poles + ⊕	81 *
CSH	10 poles + ⊕	89 *
CCE	10 poles + ⊕	96 *
CNE, CSE	10 poles + ⊕	97 *
CSS	10 poles + ⊕	119 *
CT, CTE, CTSE *)	10 poles + ⊕	127 and 131 *
CMSE	3+2 (aux) poles + ⊕	135 *
CMCE	3+2 (aux) poles + ⊕	134 *
CME	3+2 (aux) poles + ⊕	135 *
CX	8/24 poles + ⊕	151 *
MIXO	3 modules	156-195 *
CDS	18 poles + ⊕	7 **

*) only for standard insulating version THIC

* refer to CN.12 catalogue page

** refer to CDS catalogue page

insert centre distance: **57 x 27 mm**

hoods with double lever top entry



SILICONE gasket

covers



SILICONE gasket

description	part No.	entry M	part No.
with thermoplastic levers and gasket	TAVC 10 G25	25	
with thermoplastic levers and gasket	TAVC 10 G32	32	
with 4 pegs			TCHC 10
with 2 thermoplastic levers and gasket			THCC 10 G

dimensions in mm

TAVC 10 G25 and TAVC 10 G32

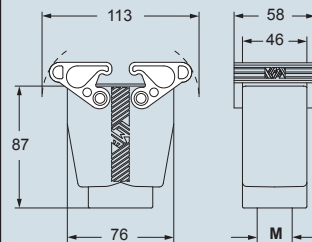

dimensions in mm

TCHC 10

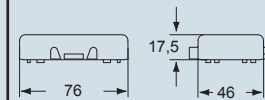

THCC 10 G

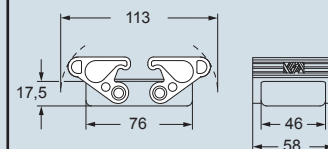

- ambient temperature limits -50 °C/+70 °C

dimensions shown are not binding and may be changed without notice

inserts:		page:
CD	40 poles + ⊕	49 *
CDD	72 poles + ⊕	62 *
CQE	32 poles + ⊕	82 *
CSH	16 poles + ⊕	90 *
CCE	16 poles + ⊕	98 *
CNE, CSE	16 poles + ⊕	99 *
CSS	16 poles + ⊕	120 *
CT, CTE, CTSE *) ..	16 poles + ⊕ 128 and 132 *	132 *
CME, CMSE 6+2 (aux)	poles + ⊕	137 *
CMCE	6+2 (aux) poles + ⊕	136 *
CP	6 poles + ⊕	149 *
CX	6/36 and 12/2 poles + ⊕	152-153 *
CX	4/0 and 4/2 poles + ⊕	154 *
MIXO	4 modules	156-195 *
CDS	27 poles + ⊕	8 **
CQEE	40 poles + ⊕	15 ***

*) only for standard insulating version THIC

* refer to CN.12 catalogue page

** refer to CDS catalogue page

*** refer to Supplement October 2013 catalogue page

insert centre distance: 77,5 x 27 mm

housings with double lever



SILICONE gasket

hoods with 4 pegs



description	part No.	entry M	part No.	entry M
bulkhead mounting housing with thermoplastic levers	THIC 16			
surface mounting housing with thermoplastic levers	TAPC 16.32	32		
surface mounting housing with thermoplastic levers	TAPC 16.40	40		
with pegs, side entry			TMAO 16.32	32
with pegs, side entry			TMAO 16.40	40
with pegs, top entry			TMAV 16.32	32
with pegs, top entry			TMAV 16.40	40

panel cut-out for bulkhead mounting housing in mm

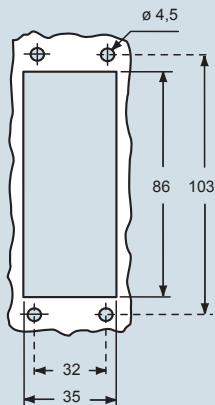

dimensions in mm

THIC 16

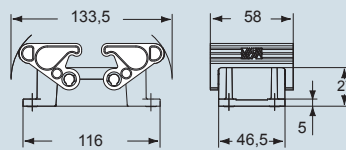

TAPC 16.32 and TAPC 16.40

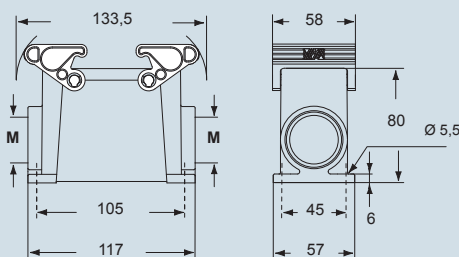

dimensions in mm

TMAO 16.32 and TMAO 16.40

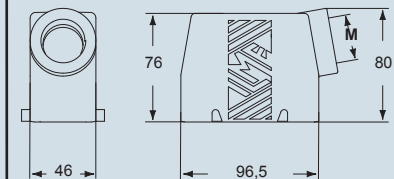

TMAV 16.32 and TMAV 16.40

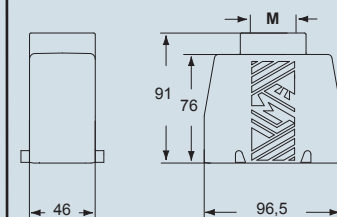

The surface mounting, high construction housings are supplied with an open threaded entry and diametrically opposite a closed threaded entry which can be opened by the user if required (with suitable tool).



- ambient temperature limits -50 °C/+70 °C

dimensions shown are not binding and may be changed without notice

inserts:		page:
CD	40 poles + ⊕	49 *
CDD	72 poles + ⊕	62 *
CQE	32 poles + ⊕	82 *
CSH	16 poles + ⊕	90 *
CCE	16 poles + ⊕	98 *
CNE, CSE	16 poles + ⊕	99 *
CSS	16 poles + ⊕	120 *
CT, CTE, CTSE *) ..	16 poles + ⊕ 128 and 132 *	
CME, CMSE 6+2 (aux)	poles + ⊕	137 *
CMCE	6+2 (aux) poles + ⊕	136 *
CP	6 poles + ⊕	149 *
CX	6/36 and 12/2 poles + ⊕	152-153 *
CX	4/0 and 4/2 poles + ⊕	154 *
MIXO	4 modules	156-195 *
CDS	27 poles + ⊕	8 **
CQEE	40 poles + ⊕	15 ***

*) only for standard insulating version THIC
 * refer to CN.12 catalogue page
 ** refer to CDS catalogue page
 *** refer to Supplement October 2013 catalogue page
 insert centre distance: 77,5 x 27 mm

hoods with double lever top entry



SILICONE gasket

covers

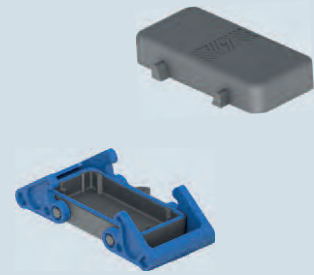

SILICONE gasket

description	part No.	entry M	part No.
with thermoplastic levers and gasket	TAVC 16 G32	32	
with thermoplastic levers and gasket	TAVC 16 G40	40	
with 4 pegs			TCHC 16
with 2 thermoplastic levers and gasket			THCC 16 G

dimensions in mm

TAVC 16 G32 and TAVC 16 G40

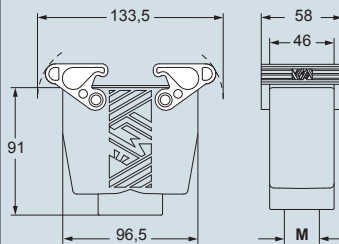

dimensions in mm

TCHC 16

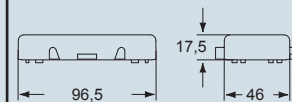

THCC 16 G

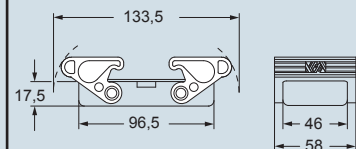

- ambient temperature limits -50 °C/+70 °C

dimensions shown are not binding and may be changed without notice

inserts:	page:
CD 64 poles + ⊕	51 *
CDD 108 poles + ⊕	64 *
CQE 46 poles + ⊕	83 *
CSH 24 poles + ⊕	91 *
CCE 24 poles + ⊕	100 *
CNE, CSE 24 poles + ⊕	101 *
CSS 24 poles + ⊕	121 *
CT, CTE, CTSE *) 24 poles + ⊕	129 and 133 *
CME, CMSE 10+2 (aux) poles + ⊕	139 *
CMCE 10+2 (aux) poles + ⊕	138 *
CME 16+2 (aux) poles + ⊕	145 *
CMCE 16+2 (aux) poles + ⊕	144 *
CX 4/8 poles + ⊕	155 *
MIXO 6 modules	156-195 *
CDS 42 poles + ⊕	9 **
CQEE 64 poles + ⊕	16 ***

*) only for standard insulating version THIC

* refer to CN.12 catalogue page

** refer to CDS catalogue page

*** refer to Supplement October 2013 catalogue page

insert centre distance: 104 x 27 mm

housings with double lever



SILICONE gasket

hoods with 4 pegs



description	part No.	entry M
bulkhead mounting housing with thermoplastic levers	THIC 24	
surface mounting housing with thermoplastic levers	TAPC 24.32	32
surface mounting housing with thermoplastic levers	TAPC 24.40	40
with pegs, side entry		
with pegs, side entry		
with pegs, top entry		
with pegs, top entry		

description	part No.	entry M
with pegs, side entry	TMAO 24.32	32
with pegs, side entry	TMAO 24.40	40
with pegs, top entry	TMAV 24.32	32
with pegs, top entry	TMAV 24.40	40

description	part No.	entry M
with pegs, side entry	TMAO 24.32	32
with pegs, side entry	TMAO 24.40	40
with pegs, top entry	TMAV 24.32	32
with pegs, top entry	TMAV 24.40	40

panel cut-out for bulkhead mounting housing in mm

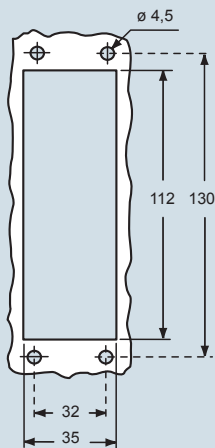

dimensions in mm

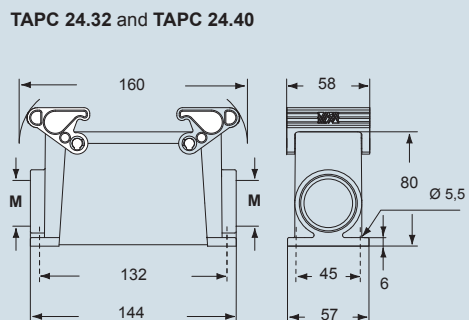
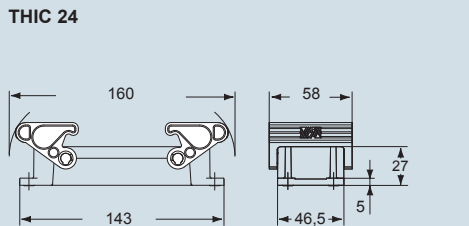

dimensions in mm

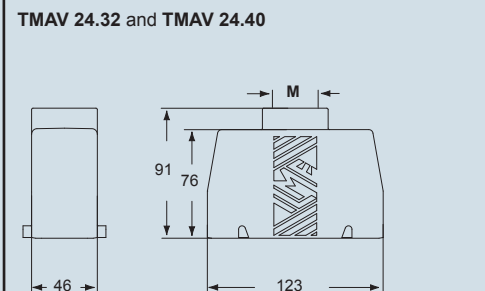
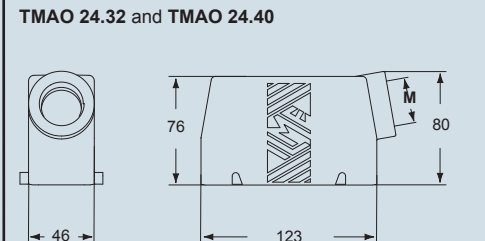

The surface mounting, high construction housings are supplied with an open threaded entry and diametrically opposite a closed threaded entry which can be opened by the user if required (with suitable tool).



- ambient temperature limits -50 °C/+70 °C

dimensions shown are not binding and may be changed without notice

inserts:		page:
CD	64 poles + ⊕	51 *
CDD	108 poles + ⊕	64 *
CQE	46 poles + ⊕	83 *
CSH	24 poles + ⊕	91 *
CCE	24 poles + ⊕	100 *
CNE, CSE	24 poles + ⊕	101 *
CSS	24 poles + ⊕	121 *
CT, CTE, CTSE *)	24 poles + ⊕	129 and 133 *
CME, CMSE 10+2 (aux)	poles + ⊕	139 *
CMCE	10+2 (aux) poles + ⊕	138 *
CME	16+2 (aux) poles + ⊕	145 *
CMCE	16+2 (aux) poles + ⊕	144 *
CX	4/8 poles + ⊕	155 *
MIXO	6 modules	156-195 *
CDS	42 poles + ⊕	9 **
CQEE	64 poles + ⊕	16 ***

*) only for standard insulating version THIC
 * refer to CN.12 catalogue page
 ** refer to CDS catalogue page
 *** refer to Supplement October 2013 catalogue page
 insert centre distance: 104 x 27 mm

hoods with double lever top entry



SILICONE gasket

covers

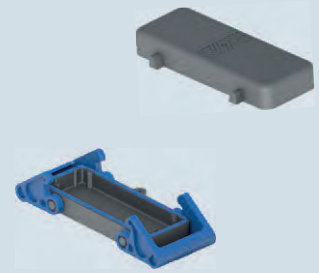

SILICONE gasket

description	part No.	entry M	part No.
with thermoplastic levers and gasket	TAVC 24 G32	32	TCHC 24
with thermoplastic levers and gasket	TAVC 24 G40	40	THCC 24 G
with 4 pegs			
with 2 thermoplastic levers and gasket			

dimensions in mm

TAVC 24 G32 and TAVC 24 G40

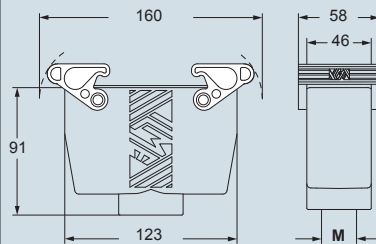

dimensions in mm

TCHC 24

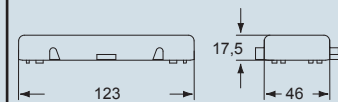

THCC 24 G

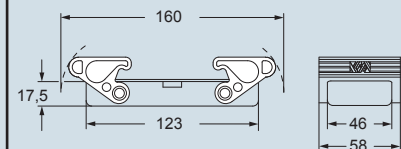

- ambient temperature limits -50 °C/+70 °C

dimensions shown are not binding and may be changed without notice

Important Notes

I.L.M.E. SpA designs and manufactures complete solutions for heavy duty electrical power connections.

The connector (although offered to the user as a variety of elements, usually inserts and enclosures, to allow the selection of the ideal combination) has been **designed as a single part** and tested to be compliant with the essential safety requirements of the EU Low Voltage Directive 2006/95/EC and in particular the EN 61984 standard.

The design of this “modular” system guarantees that every approved combination of inserts, enclosures and accessories cannot result as improper.

The products in this catalogue alone cannot guarantee the best functionality upon installation, as this depends also on their correct “installation into service” which must be performed in compliance with the applicable system safety standards and according to the “rule of the art”.

Therefore the effectiveness of the installation of the connector depends on the choices of the end user who must also take into account the following safety requirements.

Connectors must **not be connected or disconnected when live or under load**.

After wiring the inserts it is necessary **to verify the continuity of the protective earth connections**.

The correct coupling of the inserts is guaranteed only if they are installed (with the four fixing screws supplied) inside the corresponding enclosures or onto compatible accessories in this catalogue. I.L.M.E. SpA is not responsible for any different application.

Wiring of screw-type terminal connections must be carried out applying the correct tightening torque in order to avoid false contacts or damage to the conductor, the screw or the terminal.

Crimping tools and contacts used should preferably be supplied by the same manufacturer to avoid difficulties with the insertion and retention of the contacts themselves.

Correct wiring of spring-clamp connection inserts is guaranteed only when the correct screwdriver indicated in the specific catalogue, or possibly on the insert, is used.

Avoid forcing the contacts during **connection and disconnection**.

Connectors must be coupled and uncoupled in the axial direction with respect to the contacts, without bending and pulling the attached conductor bundles or cables.

Installation of two **inserts side by side**, in enclosures with two bays, must respect the polarity drawing marked on the insert (or the contact-side view, as shown in this catalogue) to avoid inverted coupling.

The installation of two or more identical connectors side by side is recommended only with the use of **coding pins** in order to avoid mismatched couplings.

In order to keep the declared degree of protection (IP code), enclosures must be completed with cable glands and/or other accessories with at least an equal protection rating.

Moreover, the IP protection rating (according to EN 60529) is guaranteed when the enclosures, complete with inserts, are coupled and locked with their locking levers (or devices).

Finally, please note:

- I.L.M.E. SpA cannot be held responsible for individual components in uses other than those described in this catalogue.

- I.L.M.E. SpA cannot be held responsible for incorrect connector selection in relation to the environmental conditions of the application (e.g.: influence of ambient temperature, moisture, environmental pollution, etc.).

Connector inserts and their enclosures are generally compatible with similar/equivalent products from other manufacturers, according to the last samples tested.

Full compatibility cannot be guaranteed in the event of technical changes made by other manufacturers. In particular, maximum performance of IP68 enclosures (Series CG) cannot be guaranteed when coupled with other manufacturers' products.

I.L.M.E. SpA takes no responsibility in verifying whether the components herein contained comply with any specific regulations of fields of application.

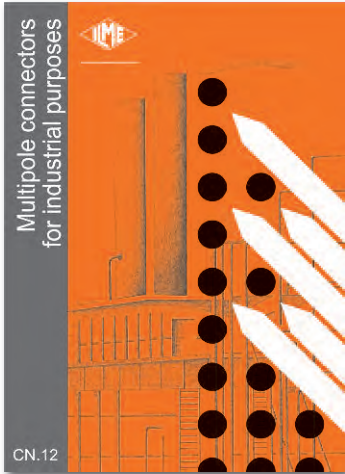

CN12
Multipole connectors



JEI® SERIES
Multipole connectors



CSH-SQUICH®
Connection without tools



CDS
High density spring connection

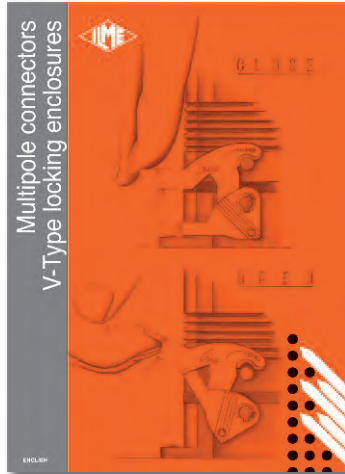

V-TYPE IP67 ENCLOSURES
V-Type locking enclosures



BIG HOODS
The space you have always wanted

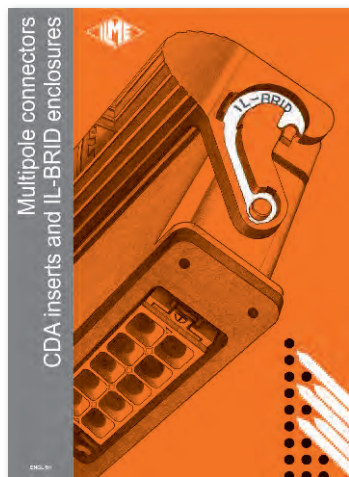

**IL-BRID ENCLOSURES
& CDA INSERTS**

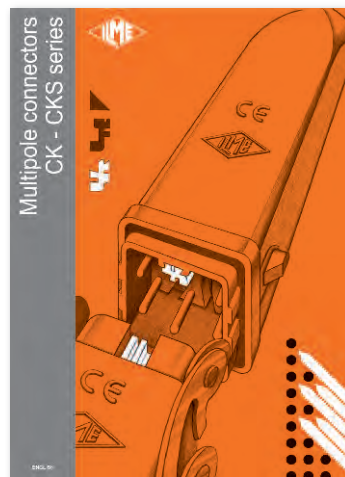

CK-CKS SERIES
With code pins

Sales Organization

Headquarter

I.L.M.E. SpA
via Marco Antonio Colonna, 9
20149 Milano - Italy
☎ +39 02345605.22 - fax +39 0233105813
www.ilme.com

France

ILME FRANCE S.A.R.L.
Rue Roland Garros - BP 125
Parc d'Activités de l'Aéroport
42163 Andrézieux-Bouthéon
☎ +33 (0) 4 77 36 23 36 - fax +33 (0) 4 77 36 97 97
e-mail: ilme-france@ilme.fr - www.ilme.fr

Germany

ILME GmbH
Max-Planck-Straße 12 - 51674 Wiehl
☎ +49 (0)2261 - 7955-0
fax +49 (0)2261 - 7955-5 (Auftragsannahme) - +49 (0)2261 - 7955-9 (Vertrieb)
e-mail: technik@ilme.de - www.ilme.de

United Kingdom

ILME UK LIMITED
50 Evans Road, Venture Point
Speke, Merseyside L24 9PB
☎ +44 (0) 151 3369321 - fax +44 (0) 151 3369326
e-mail: sales@ilmeuk.co.uk - www.ilmeuk.co.uk

Sweden and Nordic Countries

ILME NORDIC AB
Transportvägen 18
24642 Löddeköpinge (Sweden)
☎ +46 46 18 28 00 - fax +46 46 18 28 10
e-mail: info@ilme.se - www.ilme.se

Japan

ILME JAPAN CO., LTD.
Kobe International Business Center 511 - 650-0047, 5-2, 5 - Chome,
Minatojima Minami-Machi - Chuo-Ku, Kobe
☎ +81 7830 22005 - fax +81 7830 22060
www.ilme.jp

China

ILME CHINA REP. OFFICE
Room 201 Universal Centre, no. 175 XiangYan NanLu, - 200031 Shanghai
☎ +86 - 21 - 62489961 - fax +86 - 21 - 62489961
www.ilmechina.com

www.ilme.com

Ed.03/2015

XDG TH 315



8 015747 1034807



Catalogues